

**Harmonized Order to Cash (HO2C) V3  
ORDERS Branching diagram**

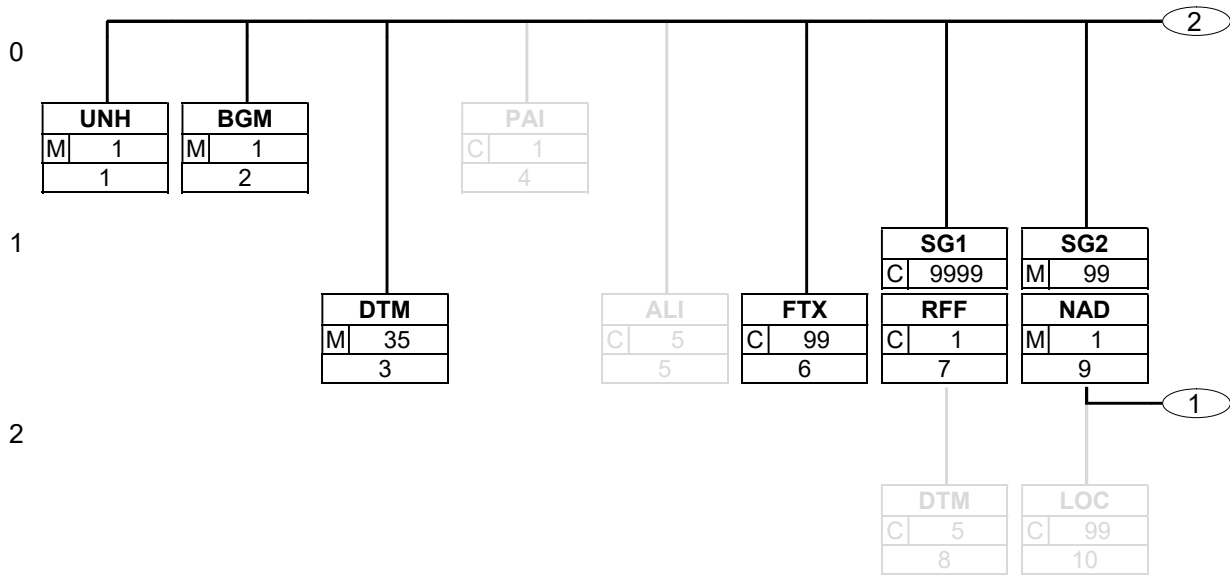

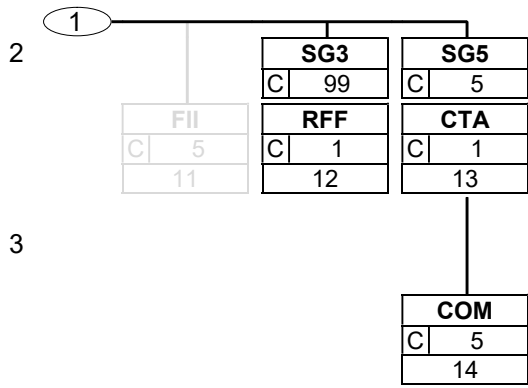

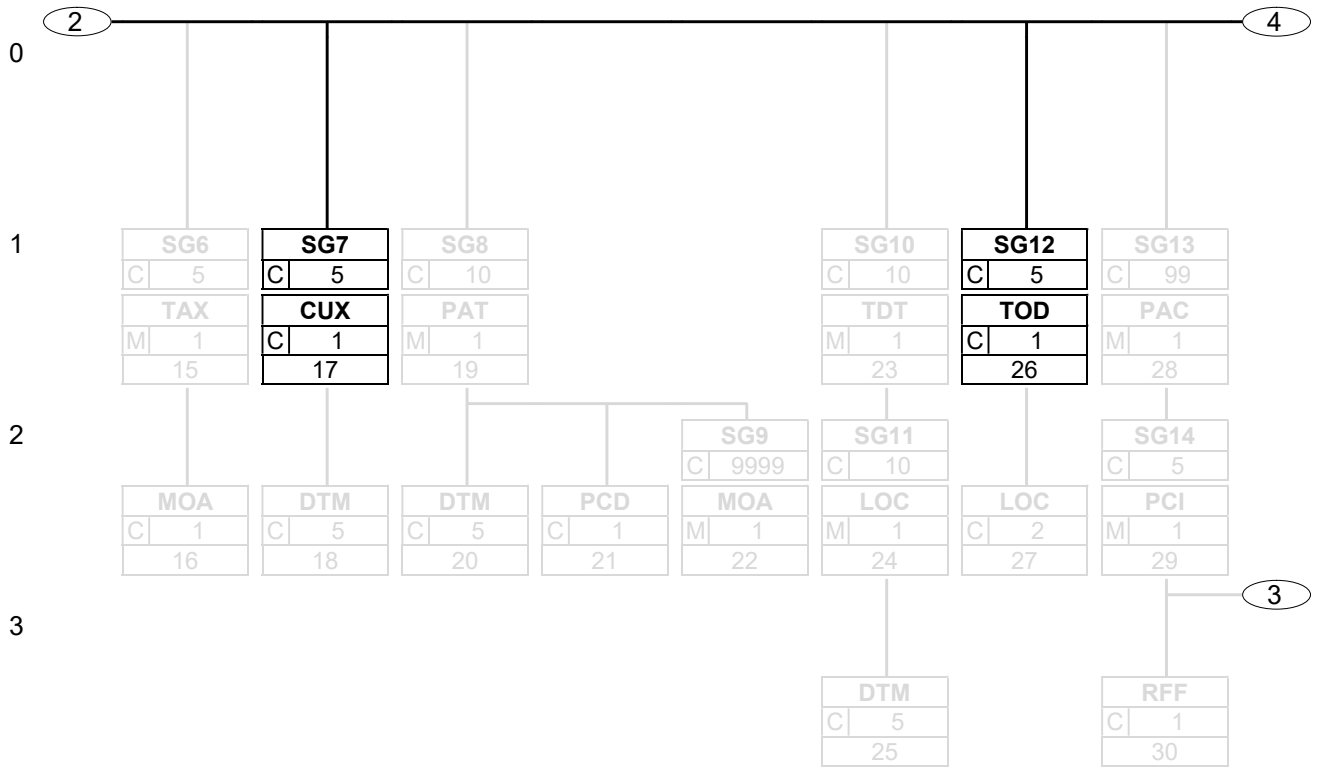



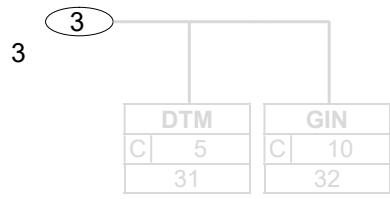

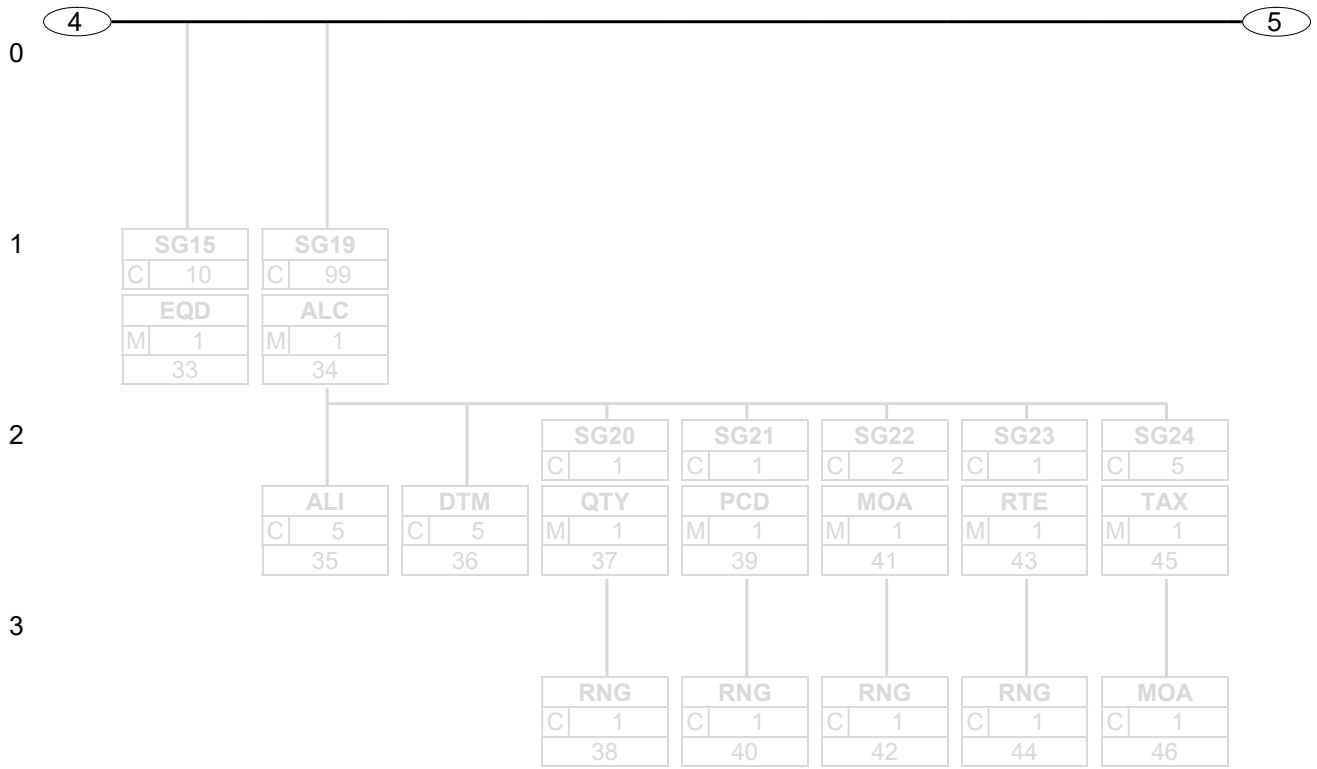

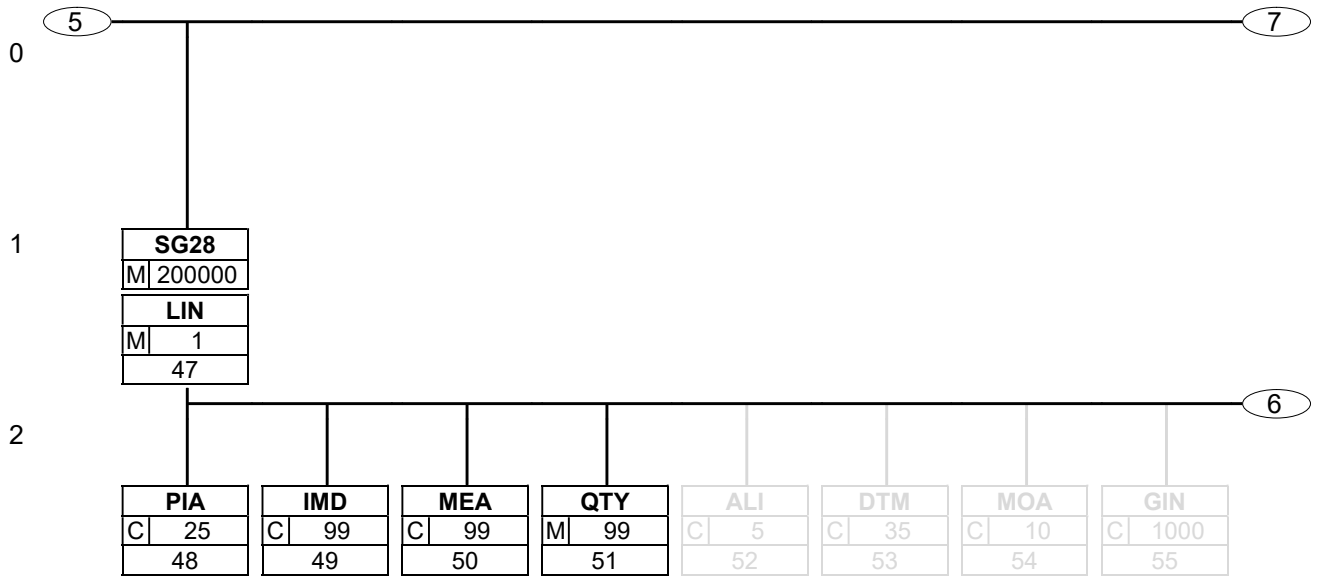



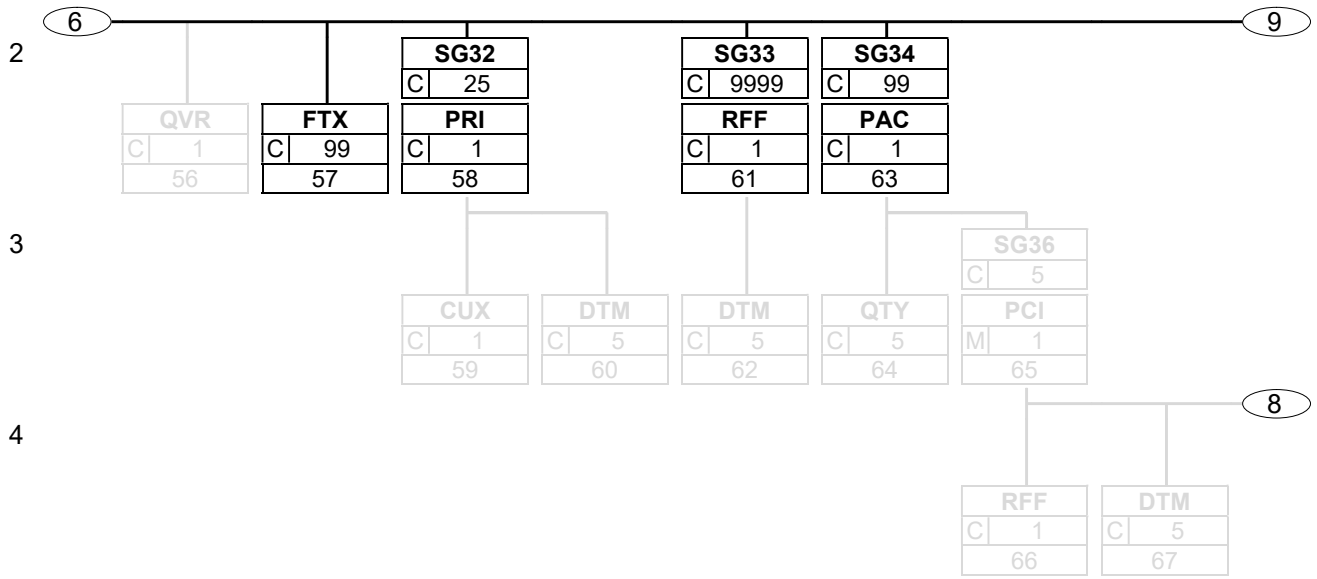

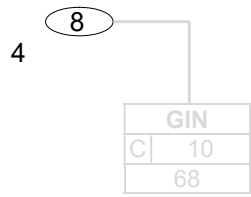

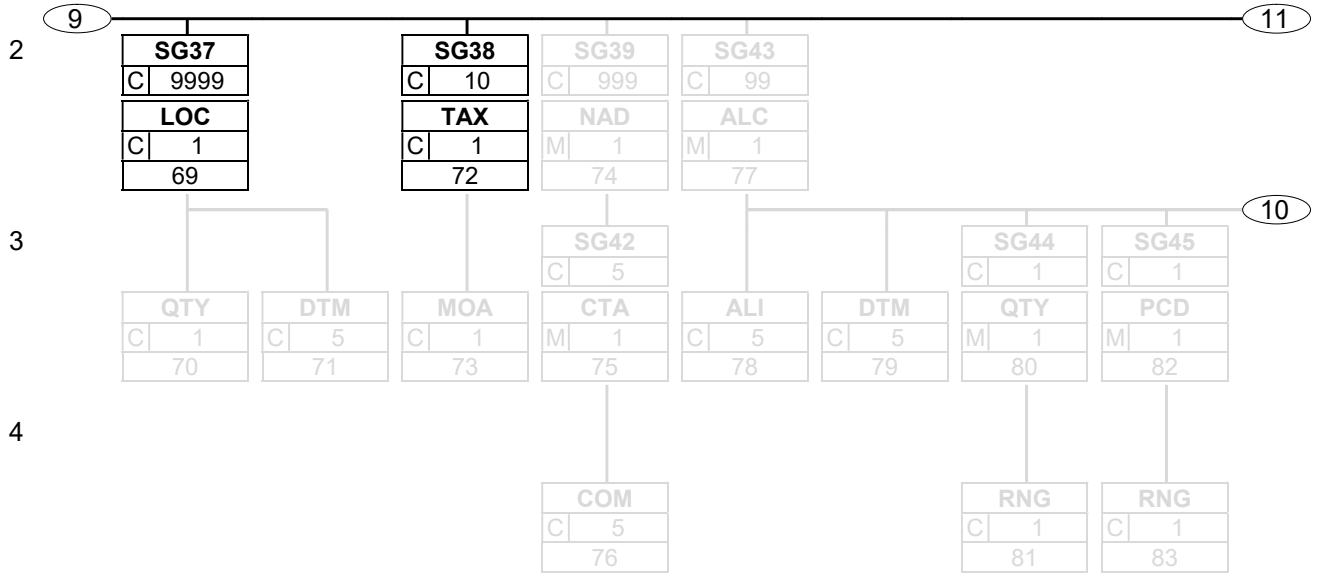

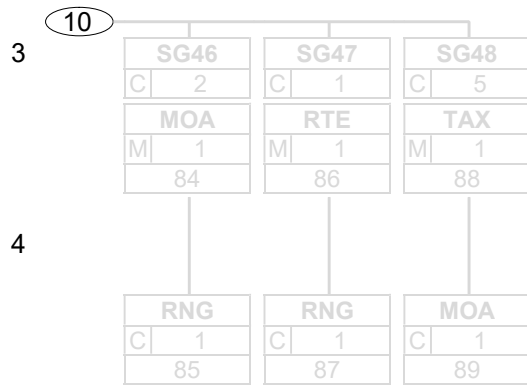

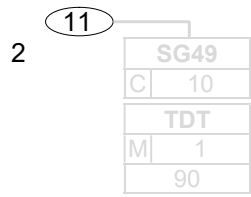

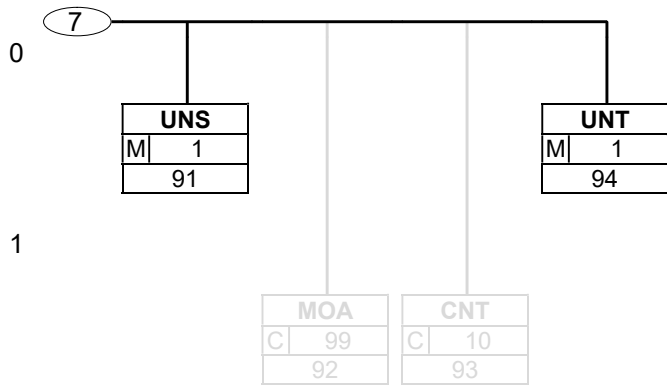



**Belgium & Luxembourg**

The Global Language of Business

**Harmonized Order to Cash (HO2C) V3  
ORDERS Message Implementation Guideline**





Segm.#	Segm.	Composite DE	DE	DE Name	MaxUse	BelgiLux	Value	Meaning	Type	Length												
<b><u>Introduction :</u></b>																						
<p>The Harmonised Order to Cash (HO2C) ORDERS MIG enables a <b>uniform implementation</b> of the EDI order for all actors in the Belgian and Luxembourgian Fast Moving Consumer Goods and Food Service sector.</p> <p>The MIG is fully compliant to EANCOM 2002 but much more refined/precise.</p> <p>HO2C is a <b>subset</b> (= "filter") of EANCOM 2002, so many segments, data elements and code qualifiers that exists in EANCOM 2002 can't be used in HO2C.</p>																						
<b>Abbreviations:</b>																						
- <b>MIG</b> = Message Implementation Guideline																						
- <b>DE</b> = Data Element																						
- <b>SG</b> = Segment Group																						
<b>Columns:</b>																						
The following columns are present throughout the MIG:																						
<table> <tr> <td>1. <b>Segm.#</b> (Segment number) :</td> <td>as in "full" EANCOM 2002 ORDERS message</td> </tr> <tr> <td>2. <b>Segm.</b> (Abbreviation segment name) :</td> <td>as in EDIFACT / EANCOM 2002 ORDERS message</td> </tr> <tr> <td>3. <i>(if present)</i> <b>Composite DE</b> :</td> <td>"</td> </tr> <tr> <td>4. <b>DE</b> (Data Element Number):</td> <td>"</td> </tr> <tr> <td>5. <b>DE name</b> :</td> <td>"</td> </tr> <tr> <td>6. <b>MaxUse</b> :</td> <td>"</td> </tr> </table>											1. <b>Segm.#</b> (Segment number) :	as in "full" EANCOM 2002 ORDERS message	2. <b>Segm.</b> (Abbreviation segment name) :	as in EDIFACT / EANCOM 2002 ORDERS message	3. <i>(if present)</i> <b>Composite DE</b> :	"	4. <b>DE</b> (Data Element Number):	"	5. <b>DE name</b> :	"	6. <b>MaxUse</b> :	"
1. <b>Segm.#</b> (Segment number) :	as in "full" EANCOM 2002 ORDERS message																					
2. <b>Segm.</b> (Abbreviation segment name) :	as in EDIFACT / EANCOM 2002 ORDERS message																					
3. <i>(if present)</i> <b>Composite DE</b> :	"																					
4. <b>DE</b> (Data Element Number):	"																					
5. <b>DE name</b> :	"																					
6. <b>MaxUse</b> :	"																					

Segm.#	Segm.	Composite DE	DE	DE Name	MaxUse	BelgiLux	Value	Meaning	Type	Length
<p><b>7. Belgilux:</b> Describes the status of each <b>segment</b> and <b>DE</b> for the O2C ORDERS MIG.</p> <p>- <b>Segment status:</b> A segment is either '<b>M</b>' (mandatory) or '<b>C</b>' (conditional).</p> <ul style="list-style-type: none"> <li>* Each mandatory segment has an explicit '<b>M</b>' indicated in the Belgilux column. This implies that the segment always has to be mentioned.</li> <li>* Conditional segments have '<b>C</b>' in the Belgilux column, they are only to be used when the condition specified in the segment note below is met.</li> </ul> <p>- <b>DE status:</b> A DE is either '<b>R</b>' (required), '<b>D</b>' (dependent), '<b>O</b>' (optional) or '<b>N</b>' (not used).</p> <ul style="list-style-type: none"> <li>* Required (<b>R</b>) DEs/values have to be mentioned (provided the segment is used).</li> <li>* Dependent (<b>D</b>) DEs/values have to be mentioned in case the dependency specified in the segment note below, is met.</li> <li>* Optional (<b>O</b>) DEs/values may be mentioned if the sender wishes to do so, but may as well stay empty (= be skipped).</li> <li>* Not used (<b>N</b>) DEs can either be used in EDIFACT but not in global EANCOM 2002, or are not retained in the scope of this national HO2C MIG.</li> </ul> <p>These DEs are in grey to stress their nonoccurrence and for improved user comfort.</p> <p>The status of the DE is repeated for each predefined value/code qualifier (see 8). All code qualifiers that have to be mentioned (depending if the condition is met), need to be described in that DE by repeating the entire segment.</p> <p><b>8. Value:</b></p> <ul style="list-style-type: none"> <li>- The DE either has a <b>predefined value</b> (from code list 'Data Elements &amp; Code Sets directory - EANCOM 2002 edition 2012').</li> <li>- or a value filled out as &lt;.&gt; because it is different each time (e.g. dates, document number, ...).</li> </ul> <p>Similarly, all GS1 Identification Keys have already been filled in as &lt;GTIN&gt; or &lt;GLN&gt;.</p> <p>- Note that the (predefined) values taken up in this MIG are considered to <b>cover all user requirements</b> for the Belgilux Fast Moving Consumer Goods sector. That is why, unlike EANCOM, this MIG does not take up the notions "open" and "restricted" code lists, since all relevant codes are already explicitly defined in the MIG.</p> <p><b>9. DE type :</b> as in EDIFACT / EANCOM 2002 ORDERS message.</p> <p><b>10. DE length :</b> compliant to EDIFACT / EANCOM 2002 ORDERS but in some cases more restricted.</p>										

Segm.#	Segm.	Composite DE	DE	DE Name	MaxUse	BelgiLux	Value	Meaning	Type	Length
<b>Changelog:</b>										
V3	01 06 2019							- Changed link to most recent RTI-list in # 63 PAC		
v2.0	01 04 2017							- All not used data-elements: added N in status and changed font color to grey to enhance user readability. - UNB missing MaxUs 1 added + DE 0026 changed value from BELU_v1 to BELU_V2 ("V" is now a capital letter!). - # 2 BGM: changed status DE 3055 from N to D + added dependency note. - # 9 NAD: changed status DE 3036, DE 3042, DE 3164, DE 3251 and DE 3207 from O to D + added dependency note. added code 719 to DE 2379 + changed status code 203 from R to D + added dependency note. - # 13 CTA: changed status C056 O => D + updated segment notes. - # 14 COM: updated segment notes. - # 48' PIA: changed status values DE 7143 O => D. - # 49 IMD: changed status C273 > DE 7009 from N to D (to not contradict #49 IMD'). - # 49' IMD: changed status C273 > DE 7008 from N to D (to not contradict #49 IMD). changed status C273 > DE 3055 from O to R . - # 61 deleted code PD from DE 1153. - # 63 PAC: changed status DE 7064 from O to R. changed status qualifiers DE 7065 from O to D + added qualifiers 204, 205, 206 and 212.		
v1.1	01 Feb 2016							- UNB DE 0026 Status changed from O to R to always indicate as an Harmonized message.		
v1.0	01 Aug 2015							- UNB DE 0026 value added.		
								- PRI (#58) clarification in segments notes.		
v1.0	01 July 2014							Release of the harmonized O2C ORDERS.		

Segm.#	Segm.	Composite DE	DE	DE Name	MaxUse	BelgiLux	Value	Meaning	Type	Length
<b>UNB Interchange header M</b>										
	UNB	<b>S001</b>		<b>Syntax identifier</b>		R				
	UNB	S001	0001	Syntax identifier		R	<b>UNOC</b>	= Character set covering capital letters, small characters and certain foreign characters.	A	1>4
	UNB	S001	0002	Syntax version number		R	<b>3</b>	= Syntax version 3	N	1
	UNB	<b>S002</b>		<b>Interchange sender</b>		R				
	UNB	S002	0004	Sender identification		R	<b>&lt;GLN&gt;</b>	= Sender GLN (Limited to 13 characters)	N	1>13
	UNB	S002	0007	Partner identification code qualifier		R	<b>14</b>	= GS1	AN	1>4
	UNB	S002	0008	Address for reverse routing		O			AN	1>14
	UNB	<b>S003</b>		<b>Interchange recipient</b>		R				
	UNB	S003	0010	Recipient identification		R	<b>&lt;GLN&gt;</b>	= Recipient GLN (Limited to 13 characters)	N	1>13
	UNB	S003	0007	Partner identification code qualifier		R	<b>14</b>	= GS1	AN	1>4
	UNB	S003	0014	Routing address		O			AN	1>14
	UNB	<b>S004</b>		<b>Date/time of preparation</b>		R				
	UNB	S004	0017	Date of preparation		R	<b>&lt;...&gt;</b>	Date format YYMMDD	N	1>6
	UNB	S004	0019	Time of preparation		R	<b>&lt;...&gt;</b>	Time format HHMM	N	1>4
	UNB		0020	Interchange control reference		R	<b>&lt;...&gt;</b>	Unique reference number generated through the sender to identify the interchange.	AN	1>14
	UNB	<b>S005</b>		<b>Recipient's reference password</b>		N				
	UNB	S005	0022	Recipient's reference/password		N			AN	1>14
	UNB	S005	0025	Recipient's reference/password qualifier		N			AN	1>2
	UNB		0026	Application reference		R	<b>BELU_V3</b>	Harmonized Order-to-Cash version 3	AN	1>14
	UNB		0029	Processing priority code		N			A	1
	UNB		0031	Acknowledgment request		N			N	1
	UNB		0032	Communications agreement ID		N			AN	1>35
	UNB		0035	Test indicator		D	<b>1</b>	Interchange is a test	N	1

Segm.#	Segm.	Composite DE	DE	DE Name	MaxUse	BelgiL ux	Value	Meaning	Type	Length
<p><i>This segment (together with UNZ) is used to envelope the interchange, as well as to identify both, the party to whom the interchange is sent and the party who has sent the interchange. The principle of the UNB segment is the same as a physical envelope which contains one or more letters, and which states the delivery and sending address.</i></p> <p><u>Dependency Notes:</u>  <b>DE0035:</b> Only use DE 0035 (= 1) when the message is in test. For messages in production, DE 0035 is not used.</p>										

Segm.#	Segm.	Composite DE	DE	DE Name	MaxUse	BelgiLux	Value	Meaning	Type	Length
<b>1</b>	<b>UNH</b>			<b>Message header</b>	<b>1</b>	<b>M</b>				
	(UNH-UNT)				(99999)					
	UNH		0062	Message reference number	R		<..>		AN	1>14
	UNH	<b>S009</b>		<b>Message identifier</b>	R					
	UNH	S009	0065	Message type	R		<b>ORDERS</b>	= Purchase order message	AN	1>6
	UNH	S009	0052	Message version number	R		<b>D</b>	=Draft version/UN/EDIFACT Directory	AN	1>3
	UNH	S009	0054	Message release number	R		<b>01B</b>	= Release 2001 - B	AN	1>3
	UNH	S009	0051	Controlling agency	R		<b>UN</b>	= UN/CEFACT	AN	1>2
	UNH	S009	0057	Association assigned code	R		<b>EAN010</b>	= GS1 version control number	AN	1>6
	UNH		0068	Common access reference	N				AN	1>35
	UNH	<b>S010</b>		<b>Status of the transfer</b>	N					
	UNH	S010	0070	Sequence of transfers	N				N	1>2
	UNH	S010	0073	First and last transfer	N				A	1>1

*This segment is used to head, identify and specify a message.*

The use of this segment is mandatory.

Segment notes:

- **DEs 0065, 0052, 0054, and 0051:** Indicate that the message is an UNSM Purchase Order based on the D.01B directory under the control of the United Nations.

Segm.#	Segm.	Composite DE	DE	DE Name	MaxUse	BelgiLux	Value	Meaning	Type	Length
<b>2 BGM</b>		<b>Beginning of message</b>			<b>1 M</b>					
	BGM	<b>C002</b>		<b>Document/message name</b>		R				
	BGM	C002	1001	Document name code		D	<b>220</b> = Order		AN	1>3
						D	<b>221</b> = Blanket order ( <i>Usage of document/message for general order purposes with later split into quantities and delivery dates and maybe delivery locations</i> )			
						D	<b>227</b> = Consignment order ( <i>Order to deliver goods into stock with agreement on payment when goods are sold out of this stock</i> )			
						D	<b>237</b> = Cross docking services order (=A document or message to order cross docking services)			
						D	<b>401</b> = Transshipment order ( <i>An order requesting the supply of products packed according to the final delivery point which will be moved across a dock in a distribution centre without further handling</i> )			
						O	<b>22E</b> = Manufacturer raised order			
	BGM	C002	1131	Code list identification code		N			AN	1>17
	BGM	C002	3055	Code list responsible agency code		D	<b>9</b> = GS1		AN	1>3
	BGM	C002	1000	Document name		N			AN	1>35
	BGM	<b>C106</b>		<b>Document/message identification</b>		R				
	BGM	C106	1004	Document identifier		R	<..>		AN	1>35
	BGM	C106	1056	Version identifier		N			AN	1>9
	BGM	C106	1060	Revision identifier		N			AN	1>6
	BGM		1225	Message function code		R	<b>9</b> = Original		AN	1>3
	BGM		4343	Response type code		N			AN	1>3

*This segment is used to indicate the type and function of the message and to transmit the identifying number.*

Segm.#	Segm.	Composite DE	DE	DE Name	MaxUse	BelgiLux	Value	Meaning	Type	Length
<p><u>Segment notes:</u>  The use of this segment is <u>mandatory</u>.  All references other than the document number (DE 1004) are to be put in the RFF segment (#7).</p> <p><u>Dependency notes:</u>  - DE 1001: Either code value <b>220, 221, 227, 237 or 401</b> (respectively 'order', 'blanket order', 'consignment order', 'cross docking services order' or 'transshipment order') is expected.  * Mention BGM+221 in case of a (season) <b>reservation order</b>.  * Mention BGM+227 in case of a <b>consignment order</b>. When to invoice 'goods in consignment' is to be bilaterally agreed beforehand.  * Mention BGM+237 in case of a <b>cross dock order</b> detailing <i>only 1</i> ultimate consignee (using #9 NAD+UC).  * Mention BGM+401 in case of a <b>transshipment order</b> detailing <i>multiple</i> ultimate destinations (using #69 LOC+7).  * Mention BGM+220 in <b>all other</b> cases (except in case of VMI).</p> <p>Code value <b>22E</b> can be used for VMI purposes. Do note however that GS1 Belgium &amp; Luxembourg has no specific recommendations in regards to VMI (yet).</p> - DE 3055: value 9 has to be used in case code 22E is used in DE 1001										



Segm.#	Segm.	Composite DE	DE	DE Name	MaxUse	BelgiLux	Value	Meaning	Type	Length
<b>3</b>	<b>DTM</b>			<b>Date/time/period</b>			<b>35 M</b>			
	DTM	<b>C507</b>		<b>Date/time/period</b>		R				
	DTM	C507	2005	Date or time or period function code qualifier		D	<b>2</b> = Requested delivery date		AN	1>3
						O	<b>63</b> = Latest delivery date			
						D	<b>64</b> = Earliest delivery date			
						R	<b>137</b> = Document/message date			
	DTM	C507	2380	Date or time or period value		R	<..>		AN	1>35
	DTM	C507	2379	Date or time or period format code		D	<b>102</b> = CCYYMMDD		AN	1>3
						D	<b>719</b> = CCYYMMDDHHMMCCYYMMDDHHMM			

*This segment is used to specify the date of the Order and, where required, requested dates concerning the delivery of the goods.*

Dependency notes:

**- DE 2005:**

- \* Identification of the 'Document/message date/time' (code value '137') is always mandatory.
- \* In addition to DTM+137 (document/message date), either DTM+2 (requested delivery date) or DTM+64 (earliest delivery date) is expected.
- \* Always mention the **requested delivery date** (DTM+2) except in case of a (season) reservation order (i.e. when BGM+221 is used).  
Note that in case of **backhauling**, DTM+2 is to be interpreted as 'requested' pick up date.
- \* Mention the **earliest delivery date** (DTM+64) in case of a (season) reservation order. Optionally specify the latest delivery date (DTM+63).

**- DE 2379:** code 719 only can be optionally used for home delivery orders (except when the delivery address is a shop) and only in the DTM+2 segment.

DTM+2:CCYYMMDDHHMMCCYYMMDDHHMM:719' can be used when the end consumer is able to select a time slot on the website of the retailer.

(for instance morning CCYYMMDD0800CCYYMMDD1200, afternoon CCYYMMDD1200CCYYMMDD1600 or evening CCYYMMDD1600CCYYMMDD2000)

In all other cases code 102 should be used.

Segm.#	Segm.	Composite DE	DE	DE Name	MaxUse	BelgiLux	Value	Meaning	Type	Length
<b>6</b>	<b>FTX</b>			<b>Free text</b>			<b>99 C</b>			
	FTX		4451	Text subject code qualifier		R		<b>PUR</b> = Purchasing information	AN	1>3
	FTX		4453	Free text function code		N			AN	1>3
	FTX	<b>C107</b>		<b>Text reference</b>		N				
	FTX	C107	4441	Free text value code		N			AN	1>17
	FTX	C107	1131	Code list identification code		N			AN	1>17
	FTX	C107	3055	Code list responsible agency code		N			AN	1>3
	FTX	<b>C108</b>		<b>Text literal</b>		R				
	FTX	C108	4440	Free text value		R	<.,>	<Free text>	AN	1>512
	FTX	C108	4440	Free text value		O			AN	1>512
	FTX	C108	4440	Free text value		O			AN	1>512
	FTX	C108	4440	Free text value		O			AN	1>512
	FTX	C108	4440	Free text value		O			AN	1>512
	FTX		3453	Language name code		O		<b>EN</b> = English	AN	1>3
						O		<b>FR</b> = French		
						O		<b>NL</b> = Dutch		
	FTX		4447	Free text format code		N			AN	1>3

*This segment is used to provide free form or coded text information for the entire purchase order.*

Segment notes:

In general, use of this segment in free form is not recommended since it may inhibit automatic processing of the order.

Nevertheless the use of this segment is **optional**. It can be used to provide additional details (e.g. in regards to consignment or the logistic flow), provided it was **bilaterally agreed** beforehand between both parties how to use/interpret the indications in FTX+PUR.

Segm.#	Segm.	Composite DE	DE	DE Name	MaxUse	BelgiLux	Value	Meaning	Type	Length
<b>SG1 RFF</b>					9999					
<b>7 RFF</b>						<b>1 C</b>				
	RFF	<b>C506</b>		<b>Reference</b>		R				
	RFF	C506	1153	Reference code qualifier		D O O	<b>ACE</b> = Related document number <b>ON</b> = Order number (buyer) <b>VN</b> = Order number (supplier)		AN	1>3
	RFF	C506	1154	Reference identifier		R	<..>		AN	1>70
	RFF	C506	1156	Document line identifier		N			AN	1>6
	RFF	C506	4000	Reference version identifier		N			AN	1>35
	RFF	C506	1060	Revision identifier		N			AN	1>6

*This segment is used to specify other references which relate to the transmission.*

Segment notes:

The references given at this point are valid for the whole order unless superseded by references at line level (#61).

Dependency notes:

- In case of a (season) **reservation** order (BGM+221), or the actual order referring to the reservation order, and provided there is a document (agreement) to refer to, it is recommended to specify the 'related document number' (via RFF+ACE).
- In case of **consignment** (BGM+227) one can optionally refer to a related document number when relevant.
- Code values ON & VN can be used for VMI purposes. Do note however that GS1 Belgium & Luxembourg has no specific recommendations in regards to VMI (yet).

Segm.#	Segm.	Composite DE	DE	DE Name	MaxUse	BelgiLux	Value	Meaning	Type	Length
<b>SG2 NAD-SG3-SG5</b>					99					
<b>9 NAD</b>				<b>Name and address</b>	1	M				
	NAD		3035	Party function code qualifier	R			<b>BY</b> = Buyer <b>DP</b> = Delivery party <b>IV</b> = Invoicee <b>SF</b> = Ship from <b>SU</b> = Supplier <b>UC</b> = Ultimate consignee	AN	1>3
	NAD	<b>C082</b>		<b>Party identification details</b>	R					
	NAD	C082	3039	Party identifier	R		<b>&lt;GLN&gt;</b>		AN	1>35
	NAD	C082	1131	Code list identification code	N				AN	1>17
	NAD	C082	3055	Code list responsible agency code	R		<b>9</b> = GS1		AN	1>3
	NAD	<b>C058</b>		<b>Name and address</b>	N					
	NAD	C058	3124	Name and address description	N				AN	1>35
	NAD	C058	3124	Name and address description	N				AN	1>35
	NAD	C058	3124	Name and address description	N				AN	1>35
	NAD	C058	3124	Name and address description	N				AN	1>35
	NAD	C058	3124	Name and address description	N				AN	1>35
	NAD	<b>C080</b>		<b>Party name</b>	D					
	NAD	C080	3036	Party name	D				AN	1>35
	NAD	C080	3036	Party name	N				AN	1>35
	NAD	C080	3036	Party name	N				AN	1>35
	NAD	C080	3036	Party name	N				AN	1>35
	NAD	C080	3036	Party name	N				AN	1>35
	NAD	C080	3045	Party name format code	N				AN	1>3
	NAD	<b>C059</b>		<b>Street</b>	D					
	NAD	C059	3042	Street and number or post office box identifier	D				AN	1>35
	NAD	C059	3042	Street and number or post office box identifier	N				AN	1>35
	NAD	C059	3042	Street and number or post office box identifier	N				AN	1>35
	NAD	C059	3042	Street and number or post office box identifier	N				AN	1>35
	NAD		3164	City name	D				AN	1>35

Segm.#	Segm.	Composite DE	DE	DE Name	MaxUse	BelgiLux	Value	Meaning	Type	Length
	NAD	<b>C819</b>		<b>Country sub-entity details</b>		O				
	NAD	C819	3229	Country sub-entity name code		O			AN	1>9
	NAD	C819	1131	Code list identification code		N			AN	1>17
	NAD	C819	3055	Code list responsible agency code		N			AN	1>3
	NAD	C819	3228	Country sub-entity name		N			AN	1>70
	NAD		3251	Postal identification code		D			AN	1>17
	NAD		3207	Country name code		D			AN	1>3

*This segment is used to identify the trading partners involved in the Order process.*

**Segment notes:**

In case of home delivery where the end consumer orders articles on the website of the retailer and the retailer forwards this orders to the supplier who has to deliver the articles at the delivery address chosen by the end consumer, the segments NAD+DP and NAD+UC are used to flag a specific subscenario:

	NAD+DP	NAD+UC
1) delivery address = invoice address end consumer	Dummy GLN 0000000000000 No address in plain text	Dummy GLN 0000000000000 Address in plain text
2) delivery address ≠ invoice address end consumer (can be relative or work)	Dummy GLN 0000000000000 Address in plain text	Dummy GLN 0000000000000 Address in plain text
3) delivery address is shop	Real GLN shop or DC  No address in plain text	Dummy GLN 0000000000000 No address in plain text

Why do we might need to make a distinction with a "normal" order when the delivery address is a shop?

For articles that are part of the fixed assortment there is no functional difference for the supplier between goods ordered by the shop to replenish the stock and goods ordered by the end consumer. The suppliers doesn't have to know that there is a difference for the retailer. So everything can be treated as a "normal" order.

There can a problem for goods that are never physically in stock (long tail articles). Often goods that can't be delivered, are ordered again by the retailer.

Back orders are often not used. For long tail articles the problem can be that those goods won't be ordered again. So this situation might need to be flagged.

Since there is no "document name code" (= order type) for this situation, the idea is to use the dummy GLN within NAD+UC as indication.

Segm.#	Segm.	Composite DE	DE	DE Name	MaxUse	BelgiLux	Value	Meaning	Type	Length
<u>Dependency notes:</u>										
<b>- DE 3035:</b>										
* Code values <b>"BY"</b> (buyer) and <b>"SU"</b> (supplier) of goods and services are always mandatory.										
* Code value <b>"DP"</b> (destination party) should always be specified, except in case of a 'reservation order', then it's optional (i.e. when #2 BGM DE 1001 = 221, <i>blanket order</i> ). The GLN in NAD+DP is to be considered as the delivery address (for all line items). An order can have only 1 delivery address. Also in case of home delivery NAD+DP will be used. When the end consumer needs to pick up the goods in a shop the GLN of the shop will be used in DE 3039. When the goods will be delivered at home or at the house of a relative or at work, the dummy GLN 0000000000000 will be used in DE 3039.										
* Code value <b>"IV"</b> (invoicee) should be used, when the invoicee is different from the <b>"BY"</b> (buyer).										
* Code value <b>"SF"</b> (ship from) or 'pick up address' should be used in 2 cases: 1) in case of backhauling. Note that NAD+DP is to be mentioned as well (for it allows to take over the delivery address in the DESADV). 2) in case of a platform order: specify the GLN of the platform/DC where the goods are stored and from where they will be shipped										
* Code value <b>"UC"</b> (ultimate consignee) should be used in 2 cases: 1) in case of a cross dock order (BGM+237, implying that <i>only 1</i> ultimate delivery location is specified), specify the ultimate delivery location in NAD+UC. <i>Note that a transshipment order however (BGM+401, detailing multiple ultimate delivery locations) uses #69 LOC+7 (instead of NAD+UC) to specify the locations.</i> 2) in case of home delivery: to specify that the ultimate consignee is an end consumer. This is indicated with the dummy GLN 0000000000000 in DE 3039.										
<b>- DE 3036, DE 3042, DE 3164, DE 3229, DE 3251 and DE 3207:</b>										
* Specify optionally each party's name and address on top of the GLN in case the receiver of the order uses a webEDI solution that requires this data for easier handling.										
* NAD+DP: in case of home delivery if the delivery address is not the same as the invoice address of the end consumer these DEs should be used to specify the alternative delivery address. This can be the address of a relative or the company where the end consumer works. The DEs shouldn't be used when the end consumer wants the goods to be delivered in a store, since that store has a real GLN and the address is exchanged via master data.										
* NAD+UC: in case of home delivery order this DEs should be used to specify the address of the end consumer, except in the case he chooses that the goods should be delivered in a shop.										
Note: As for the <b>'issuer of the invoice'</b> , note that this party is <i>not</i> to be derived from the ORDERS, but should be agreed beforehand.										

Segm.#	Segm.	Composite DE	DE	DE Name	MaxUse	BelgiLux	Value	Meaning	Type	Length
	<b>SG2 NAD-SG3-SG5</b>				99					
	<b>SG3 RFF</b>				99					
	<b>12 RFF</b>			<b>Reference</b>	1	C				
	RFF	<b>C506</b>		<b>Reference</b>		R				
	RFF	C506	1153	Reference code qualifier		D	<b>YC1</b> = Additional party identification		AN	1>3
						O	<b>VA</b> = VAT registration number			
	RFF	C506	1154	Reference identifier		R	<.>		AN	1>70
	RFF	C506	1156	Document line identifier		N			AN	1>6
	RFF	C506	4000	Reference version identifier		N			AN	1>35
	RFF	C506	1060	Revision identifier		N			AN	1>6

*This segment is used to specify reference numbers related to the party specified in the previous NAD segment (#9).*

Dependency notes:

**- DE 1153**

\*Only mention RFF+YC1:<internal trading partner identification>' for NAD+SU when several departments of the supplier are known at the retailer by one and the same GLN (and thus need to be distinguished).

Nevertheless, whenever relevant, the supplier should identify each entity with a separate GLN (and avoid such additional identification).

\*Although redundant if proper data synchronisation is in place, RFF+VA can optionally be used to specify the VAT registration number of the party in NAD+IV, for instance in case the receiver of the order uses a **webEDI** solution that requires this data for the creation of the invoice.

Segm.#	Segm.	Composite DE	DE	DE Name	MaxUse	BelgiLux	Value	Meaning	Type	Length
<b>SG2 NAD-SG3-SG5</b>					99					
<b>SG5 CTA-COM</b>					5					
<b>13 CTA Contact information</b>					1	C				
	CTA		3139	Contact function code		D		<b>GR</b> = Goods receiving contact (contact at logistic department)	AN	1>3
						D		<b>PD</b> = Purchasing contact (contact at purchase department)		
	CTA	<b>C056</b>		<b>Department or employee details</b>		D				
	CTA	C056	3413	Department or employee name code		N			AN	1>17
	CTA	C056	3412	Department or employee name		R	<.>	First name & surname of the contact person	AN	1>35

*This segment is used to identify contact details for the party specified in the previous NAD segment.*

Segment notes:

This segment may optionally be used to provide the name of the person to contact to make a docking reservation. It should be used to provide the contact details of the end consumer in case of a home delivery order. In that way the supplier is able to contact the end consumer when needed. The segment should not be used when the end consumer selected a store as delivery address. In that case the supplier doesn't need to know this information.

Dependency notes:

- **DE 3139:** in case of home delivery order:
  - \* in NAD+UC use "PD" without the name of the end consumer in DE 3412, since the name of the end consumer already appears in DE 3036 of NAD+UC.
  - \* in NAD+DP use "GR" with the name of the end consumer in DE 3412, since the name in DE 3036 of NAD+DP will be the name of the relative or the name of the company where the end consumer works.



Segm.#	Segm.	Composite DE	DE	DE Name	MaxUse	BelgiLux	Value	Meaning	Type	Length
<b>SG2 NAD-SG3-SG5</b>					99					
<b>SG5 CTA-COM</b>					5					
<b>14 COM Contact Communication Info</b>					5	C				
	COM	C076		Communication contact		R				
	COM	C076	3148	Communication address identifier		R	<..>		AN	1>72
	COM	C076	3155	Communication address code qualifier		D	<b>EM</b> = Electronic mail		AN	1>3
						D	<b>TE</b> = Telephone			

*This segment identifies the communication number, and type of communications, for the person or department identified in the preceding CTA segment.*

Segment notes:

This segment is used to provide the contact details of the person specified in the segment above.

It should be used in case of home delivery except if the end consumer chooses a store as alternative delivery address. In that case the supplier doesn't need to know this information. In all other cases the usage of this segment is optional.

Segm.#	Segm.	Composite DE	DE	DE Name	MaxUse	BelgiLux	Value	Meaning	Type	Length
<b>SG7 CUX</b>					5					
<b>17 CUX</b>					1	C				
	CUX	<b>C504</b>		<b>Currency details</b>		R				
	CUX	C504	6347	Currency usage code qualifier		R	<b>2</b> = Reference currency		AN	1>3
	CUX	C504	6345	Currency identification code		R	<b>EUR</b>		AN	1>3
	CUX	C504	6343	Currency type code qualifier		R	<b>9</b> = Order currency		AN	1>3
	CUX	C504	6348	Currency rate value		N			N	1>4
	CUX	<b>C504</b>		<b>Currency details</b>		N				
	CUX	C504	6347	Currency usage code qualifier		N			AN	1>3
	CUX	C504	6345	Currency identification code		N			AN	1>3
	CUX	C504	6343	Currency type code qualifier		N			AN	1>3
	CUX	C504	6348	Currency rate value		N			N	1>4
	CUX		5402	Currency exchange rate		N			N	1>12
	CUX		6341	Exchange rate currency market identifier		N			AN	1>3

*This segment is used to specify currency information for the complete order.*

Segment notes:

The use of this segment is **optional** and is only relevant if #58 PRI is used (e.g. in case of webEDI or international exchanges).

Segm.#	Segm.	Composite DE	DE	DE Name	MaxUse	BelgiLux	Value	Meaning	Type	Length
<b>SG12 TOD</b>					5					
<b>26 TOD</b>					1	C				
	TOD		4055	Delivery or transport terms function code		D		<b>4</b> = Collected by customer (backhauling)	AN	1>3
	TOD		4215	Transport charges payment method code		N		<b>6</b> = Delivery condition	AN	1>3
	TOD	<b>C100</b>		<b>Terms of delivery or transport</b>		O				
	TOD	C100	4053	Delivery or transport terms description code		O		<b>DDP</b> = Delivery duty paid to destination	AN	1>3
	TOD	C100	1131	Code list identification code		N		<b>EXW</b> = Ex works	AN	1>17
	TOD	C100	3055	Code list responsible agency code		N			AN	1>3
	TOD	C100	4052	Delivery or transport terms description		N			AN	1>70
	TOD	C100	4052	Delivery or transport terms description		N			AN	1>70

*This segment is used to specify the terms of delivery for the complete order.*

Segment notes:

Generally the **delivery condition** is agreed beforehand. Those who wish may however mention it in the ORDERS message for information purposes only. This information is supposed to correspond to what was agreed beforehand. **If another delivery condition applies, then this should be agreed beforehand.**

Dependency notes:

- In case of **backhauling**, TOD+4 is to be mentioned. Optionally DE 4053 (= EXW) may be specified as well.
- **DE 4053**: Code value "EXW" can only be used if DE 4055 has value "4".
- **DE 4053**: Code value "DDP" can only be used if DE 4055 has value "6".

Segm.#	Segm.	Composite DE	DE	DE Name	MaxUse	BelgiLux	Value	Meaning	Type	Length
<b>SG28 LIN-PIA-IMD-MEA-QTY-FTX-SG32-SG33-SG34-SG37-SG38</b>					200000					
<b>47 LIN</b>					1	M				
	LIN		1082	Line item identifier	R		<..>	Sequential number	AN	1>6
	LIN		1229	Action request/notification description code	N				AN	1>3
	LIN	<b>C212</b>		<b>Item number identification</b>	D					
	LIN	C212	7140	Item identifier	R		<GTIN>		AN	1>35
	LIN	C212	7143	Item type identification code	R		<b>SRV</b> = GS1 Global Trade Item Number		AN	1>3
	LIN	C212	1131	Code list identification code	N				AN	1>17
	LIN	C212	3055	Code list responsible agency code	N				AN	1>3
	LIN	<b>C829</b>		<b>Sub-line information</b>	N					
	LIN	C829	5495	Sub-line indicator code	N				AN	1>3
	LIN	C829	1082	Line item identifier	N				AN	1>6
	LIN		1222	Configuration level number	N				N	1>2
	LIN		7083	Configuration operation code	N				AN	1>3

*This segment is used to identify the item being ordered.*

#### Segment notes:

The detail section of the Purchase Order is formed by a repeating group of segments, always starting with the LIN segment.

The use of **GTINs** is mandatory in the scope of the Belgian retail sector.

- Ideally, the LIN segment specifies the 'GTIN of the **trade unit**' (e.g. a box, carton, pallet or any other unit which is commercially agreed to be ordered and invoiced).

This can be a GTIN-13 or a GTIN-14 (with leading character 1-9).

Furthermore, the best practice is to **take over** the GTIN in the DESADV and INVOIC message (for direct matching), even if it concerns a consumer unit.

- Do note however that although it's recommended to always order in trade units, for a few specific business cases (e.g. for French suppliers)

some will order in '**consumer units**'. For information purposes, some additional segment lines can then optionally be used.

(I.e. #49 IMD+F++:::<article description>', #51 QTY+59 for the n° of consumer units per trade unit, and #63 PAC for the expected n° of packages.)

#### Dependency notes:

- C212 is always expected in the LIN segment except in case the customer explicitly orders '**empty RTI**' (such as empty pallets, crates etc).

For more information, see 'ORDERS examples'.

GS1 Belgium Luxembourg  
Koningsstraat 76 b1  
1000 Brussel

☎ : +32 (0) 2 229 18 88  
✉ : fmcg-foodservice@gs1belu.org

Segm.#	Segm.	Composite DE	DE	DE Name	MaxUse	BelgiLux	Value	Meaning	Type	Length
<b>SG28 LIN-PIA-IMD-MEA-QTY-FTX-SG32-SG33-SG34-SG37-SG38</b>					200000					
48	PIA			<b>Additional product id</b>	25	C		<b>Ordering empty RTI</b>		
	PIA		4347	Product identifier code qualifier		R	<b>5</b>	= Product identification	AN	1>3
	PIA	<b>C212</b>		<b>Item number identification</b>		R				
	PIA	C212	7140	Item identifier		R	<b>&lt;nGRAI&gt;</b>	Select nGRAI from the RTI list	AN	1>35
	PIA	C212	7143	Item type identification code		R	<b>SUE</b>	= Non serialized GS1 Global Returnable Asset Identifier	AN	1>3
	PIA	C212	1131	Code list identification code		N			AN	1>17
	PIA	C212	3055	Code list responsible agency code		N			AN	1>17
	PIA	<b>C212</b>		<b>Item number identification</b>		N				
	PIA	C212	7140	Item identifier		N		<i>For easier reading, the PIA segment is split up in separate pages to indicate working method for 'empty RTI' (here) and 'additional identification' (next page).</i>	AN	1>35
	PIA	C212	7143	Item type identification code		N			AN	1>3
	PIA	C212	1131	Code list identification code		N			AN	1>17
	PIA	C212	3055	Code list responsible agency code		N			AN	1>17
	PIA	C212	3055	Code list responsible agency code		N			AN	1>17

*This segment is used to specify additional item identification codes.*

**Segment notes:**

This segment can be used to order '**empty RTI's**' (such as specific pallets, crates, etc). For more information, see 'ORDERS examples'.

The RTI list can be downloaded over here: [https://www.gs1.nl/sites/default/files/so\\_emballagecodes\\_gs1beneluxrtilist.pdf](https://www.gs1.nl/sites/default/files/so_emballagecodes_gs1beneluxrtilist.pdf)

Segm.#	Segm.	Composite DE	DE	DE Name	MaxUse	BelgiLux	Value	Meaning	Type	Length
<b>SG28 LIN-PIA-IMD-MEA-QTY-FTX-SG32-SG33-SG34-SG37-SG38</b>					200000					
<b>48' PIA</b>			<b>Additional product id</b>		25	C	<b>Additional identification</b>			
	PIA		4347	Product identifier code qualifier		R	<b>1</b>	= Additional identification	AN	1>3
	PIA	<b>C212</b>		<b>Item number identification</b>						
	PIA	C212	7140	Item identifier		R	<..>	<Internal number>	AN	1>35
	PIA	C212	7143	Item type identification code		D	<b>SA</b>	= Supplier's article number	AN	1>3
						D	<b>IN</b>	= Buyer's item number		
	PIA	C212	1131	Code list identification code		N			AN	1>17
	PIA	C212	3055	Code list responsible agency code		N			AN	1>17
	PIA	<b>C212</b>		<b>Item number identification</b>		N				
	PIA	C212	7140	Item identifier		N			AN	1>35
	PIA	C212	7143	Item type identification code		N			AN	1>3
	PIA	C212	1131	Code list identification code		N			AN	1>17
	PIA	C212	3055	Code list responsible agency code		N			AN	1>17

*This segment is used to specify additional item identification codes.*

Segment notes:

The use of this segment is **optional**.

Code value IN (buyer's item number) can for instance be used when several suppliers' product **variants** share the same GTIN number, or when a supplier has to take into account different **packing requirements** per ultimate customer (although in the latter case a distinction by a separate GTIN would seem more appropriate).

Segm.#	Segm.	Composite DE	DE	DE Name	MaxUse	BelgiLux	Value	Meaning	Type	Length
<b>SG28 LIN-PIA-IMD-MEA-QTY-FTX-SG32-SG33-SG34-SG37-SG38</b>					200000					
<b>49 IMD</b>					99	C				
	IMD		7077	Description format code	R		F = Free-form		AN	1>3
	IMD	C272		Item characteristic	N					
	IMD	C272	7081	Item characteristic code	N				AN	1>3
	IMD	C272	1131	Code list identification code	N				AN	1>17
	IMD	C272	3055	Code list responsible agency code	N				AN	1>3
	IMD	C273		Item description	R					
	IMD	C273	7009	Item description code	D				AN	1>17
	IMD	C273	1131	Code list identification code	N				AN	1>17
	IMD	C273	3055	Code list responsible agency code	D				AN	1>3
	IMD	C273	7008	Item description	R		<..> <Description of the article>		AN	1>256
	IMD	C273	7008	Item description	N				AN	1>256
	IMD	C273	3453	Language name code	N				AN	1>3
	IMD		7383	Surface or layer code	N				AN	1>3

*This segment is used to describe the current line item.  
It is recommended that this segment is only used for coded descriptions.*

*For easier reading, the IMD segment is split up in separate pages to indicate working method for 'article description' (here) and 'other information' (next page).*

**Segment notes:**

The use of this segment is **optional**.

Although redundant if proper data synchronisation is in place, it can be used to specify the article description (on top of the GTIN) in case the receiver of the order uses a **webEDI solution** that requires this data for easier handling.

Segm.#	Segm.	Composite DE	DE	DE Name	MaxUse	BelgiLux	Value	Meaning	Type	Length
<b>SG28</b>	<b>LIN-PIA-IMD-MEA-QTY-FTX-SG32-SG33-SG34-SG37-SG38</b>				<b>200000</b>					
<b>49'</b>	<b>IMD</b>			<b>Item description</b>	<b>99</b>	<b>C</b>				
	IMD		7077	Description format code	R		<b>C</b> = Code (from industry code list)		AN	1>3
	IMD	<b>C272</b>		<b>Item characteristic</b>	N					
	IMD	C272	7081	Item characteristic code	N				AN	1>3
	IMD	C272	1131	Code list identification code	N				AN	1>17
	IMD	C272	3055	Code list responsible agency code	N				AN	1>3
	IMD	<b>C273</b>		<b>Item description</b>	R					
	IMD	C273	7009	Item description code	D		<b>CU</b> = Consumer unit		AN	1>17
					D		<b>TU</b> = Traded unit			
	IMD	C273	1131	Code list identification code	N				AN	1>17
	IMD	C273	3055	Code list responsible agency code	R		<b>9</b> = GS1		AN	1>3
	IMD	C273	7008	Item description	D				AN	1>256
	IMD	C273	7008	Item description	N				AN	1>256
	IMD	C273	3453	Language name code	N				AN	1>3
	IMD		7383	Surface or layer code	N				AN	1>3

*This segment is used to describe the current line item. It is recommended that this segment is only used for coded descriptions.*

**Segment notes:**

The use of this segment is **optional**.

Although redundant if proper data synchronisation is in place, it can be used (for information purposes only) to specify if the ordered article is a **consumer unit (CU)** or a **trade unit (TU)**.



Segm.#	Segm.	Composite DE	DE	DE Name	MaxUse	BelgiLux	Value	Meaning	Type	Length
<b>SG28 LIN-PIA-IMD-MEA-QTY-FTX-SG32-SG33-SG34-SG37-SG38</b>					200000					
<b>50 MEA Measurements</b>					99	C				
	MEA		6311	Measurement purpose code qualifier		R		<b>PD</b> = Physical dimensions (product ordered)	AN	1>3
	MEA	<b>C502</b>		<b>Measurement details</b>		R				
	MEA	C502	6313	Measured attribute code		D		<b>AAC</b> = Total net weight	AN	1>3
						O		<b>LAY</b> = Number of layers		
						O		<b>ULY</b> = N° of units per layer		
	MEA	C502	6321	Measurement significance code		O		<b>4</b> = Equal to	AN	1>3
	MEA	C502	6155	Non-discrete measurement name code		N			AN	1>17
	MEA	C502	6154	Non-discrete measurement name		N			AN	1>70
	MEA	<b>C174</b>		<b>Value/range</b>		R				
	MEA	C174	6411	Measurement unit code		D		<b>KGM</b> = Kilogram	AN	1>3
						D		<b>MTR</b> = Meter		
						D		<b>LTR</b> = Liter		
						D		<b>PCE</b> = Piece		
	MEA	C174	6314	Measurement value		R		<b>&lt;..&gt;</b> EANCOM recommends max. 3 decimal digits.	AN	1>18
	MEA	C174	6162	Range minimum value		N			N	1>18
	MEA	C174	6152	Range maximum value		N			N	1>18
	MEA	C174	6432	Significant digits quantity		N			N	1>2
	MEA		7383	Surface or layer code		N			AN	1>3

This segment is used to specify the actual physical dimensions of the ordered item where that item is sold in variable quantities (i.e. length, volume, weight).

**Segment notes:**

This segment is used for articles that can only be expressed in kg, m or l. Typically these articles are ordered in bulk (and are identified by GTIN-14 starting with a '9') .

Segm.#	Segm.	Composite DE	DE	DE Name	MaxUse	BelgiLux	Value	Meaning	Type	Length
<p><u>Dependency notes:</u></p> <ul style="list-style-type: none"> <li>- Code value 'AAC' (DE 6313) implies that the weight (or length or volume) specified in DE 6314 is to be considered as the <b>total sum of the net weight</b> (or respectively length or volume) of all ordered items. We could e.g. imagine that 10 crates are ordered (QTY+21:10') representing approximately 100 kg in total.</li> <li>- Only for specific business cases and provided it was bilaterally agreed beforehand, the sender of the order may specify the number of layers (LAY) and the number of units (ULY) expected, expressed in pieces (using DE 6411 = PCE). This is to ensure that the dimensions of the logistic unit will fit in the DC storage space. E.g. MEA+PD+LAY:4+PCE:5' (meaning '5 layers per pallet are expected') and MEA+PD+ULY:4+PCE:24' (meaning '24 units per layer are expected').</li> </ul>										

Segm.#	Segm.	Composite DE	DE	DE Name	MaxUse	BelgiLux	Value	Meaning	Type	Length
<b>SG28 LIN-PIA-IMD-MEA-QTY-FTX-SG32-SG33-SG34-SG37-SG38</b>					200000					
<b>51 QTY</b>					99	M				
	QTY	<b>C186</b>		<b>Quantity details</b>		R				
	QTY	C186	6063	Quantity type code qualifier		D	<b>21</b> = Ordered quantity		AN	1>3
						D	<b>192</b> = Free goods quantity			
						O	<b>59</b> = Number of consumer units per trade unit			
	QTY	C186	6060	Quantity		R	<..>		AN	1>35
	QTY	C186	6411	Measurement unit code		N			AN	1>3

*This segment is used to specify the total quantity ordered for the current line identified in the LIN segment.*

Dependency notes:

**- DE 6063:**

\*For each LIN segment either **QTY+21** (ordered quantity) or **QTY+192** (free goods quantity) is expected.

\***QTY+192**: 'Free goods quantity' is to be considered as the commercially agreed '**truly free**' quantity whereas QTY+21 is to be considered as the 'ordered, payable' quantity.

\*If both a 'free' quantity and a 'payable' quantity of an article are ordered, a repetition of the LIN segment is necessary to unambiguously identify/separate both situations.

If only 'free' quantity is ordered, then only specify QTY+192 (and leave out QTY+21).

\***QTY+59**: Although redundant when proper data synchronisation is in place, it may be optionally useful to express **how many consumer units are expected per trade** unit for instance in case consumer units are ordered (instead of trade units).

Note: In the case of **transshipment** (BGM+401, detailing *multiple* ultimate destinations) the quantity per ultimate destination is to be specified in #51 QTY by repeating the LIN segment group for each ultimate destination. For more information, see 'ORDERS examples'.

*(Note however that contrary to EANCOM recommendations, the GS1 Belgium eCom Committee decided to not withhold #70 LOC.QTY.*

*This is because #51 QTY allows to express free quantity and variable weight quantity according to the recommendations in this document, whereas #70 does not).*

Segm.#	Segm.	Composite DE	DE	DE Name	MaxUse	BelgiLux	Value	Meaning	Type	Length
<b>SG28 LIN-PIA-IMD-MEA-QTY-FTX-SG32-SG33-SG34-SG37-SG38</b>					200000					
<b>57 FTX Free Text</b>					99	C				
	FTX		4451	Text subject code qualifier		R	<b>PUR</b>	= Purchasing information	AN	1>3
	FTX		4453	Free text function code		N			AN	1>3
	FTX	<b>C107</b>		<b>Text reference</b>		N				
	FTX	C107	4441	Free text value code		N			AN	1>17
	FTX	C107	1131	Code list identification code		N			AN	1>17
	FTX	C107	3055	Code list responsible agency code		N			AN	1>3
	FTX	<b>C108</b>		<b>Text literal</b>		R				
	FTX	C108	4440	Free text value		R	<..>	<Free text>	AN	1>512
	FTX	C108	4440	Free text value		N			AN	1>512
	FTX	C108	4440	Free text value		N			AN	1>512
	FTX	C108	4440	Free text value		N			AN	1>512
	FTX	C108	4440	Free text value		N			AN	1>512
	FTX		3453	Language name code		N			AN	1>3
	FTX		4447	Free text format code		N			AN	1>3

*This segment is used to specify any special requirements for the current line item.*

Segment notes:

The use of this segment is **optional**.

- It can be used to explicitly indicate that the ordered article concerns a **promotional** article (in case it carries the same GTIN as the non-promotional article).
- Only if **bilaterally agreed** beforehand, the sender of the order may specify for one (/more) GTIN(s) that this (/these) is (/are) to be considered as '**priority**', thus ensuring that this (/these) GTIN(s) would definitely be delivered.

Segm.#	Segm.	Composite DE	DE	DE Name	MaxUse	BelgiLux	Value	Meaning	Type	Length
<b>SG28 LIN-PIA-IMD-MEA-QTY-FTX-SG32-SG33-SG34-SG37-SG38</b>					200000					
<b>SG32 PRI</b>					25					
<b>58 PRI</b>					1	C				
				<b>Price details</b>						
	PRI	<b>C509</b>		<b>Price information</b>		R				
	PRI	C509	5125	Price code qualifier		R	<b>AAA</b>	= Calculation net	AN	1>3
	PRI	C509	5118	Price amount		R	<b>&lt;.&gt;</b>	EANCOM recommends 4 decimal digits.	N	1>15
	PRI	C509	5375	Price type code		O	<b>CT</b>	= Contract	AN	1>3
	PRI	C509	5387	Price specification code		O	<b>AAE</b>	= Not subject to fluctuation	AN	1>3
						O	<b>CP</b>	= Current price		
	PRI	C509	5284	Unit price basis value		O	<b>&lt;.&gt;</b>	<1>	N	1>9
	PRI	C509	6411	Measurement unit code		O	<b>PCE</b>	= Piece	AN	1>3
						O	<b>KGM</b>	= Kilogram		
	PRI		5213	Sub-line item price change operation code		N			AN	1>3

*This segment is used to detail the price for the current product identified in the LIN segment (#47).*

#### Segment notes:

- Whenever possible, this segment should be avoided. Therefore only transmit a price if really necessary e.g. for certain **webEDI** requiring this data to take over in the invoice, or if **bilaterally agreed** to cover a specific business case.  
Under no circumstances is the order to generate an action from the supplier in case the (optionally mentioned) price is different from what was commercially agreed. In spite of that, the supplier may of course contact the retailer but he/she's not expected to do so. It goes without saying that when creating the invoice, the supplier is to take care of transmitting the correct price to the customer.
- The **PRI segment** can only be used provided the CUX segment (#17) at header level is used.
- **DE 5118**: The calculation price will always be the indicative **Net Unit Price** (= Gross Price + Charges - Allowances).
- **DE 5284**: If used, it was agreed within the GS1 Belgium eCom Committee that the unit price basis value can only express value '1'. This implies that the price can only be expressed per (1) kg or piece (instead of e.g. price per 200 kg).
- **DE 6411**: Generally this data element is only used for variable quantity products (to express the **price per kg**), but exceptionally for specific business cases one can express the price **per piece**, provided this practice is bilaterally agreed beforehand.

Segm.#	Segm.	Composite DE	DE	DE Name	MaxUse	BelgiLux	Value	Meaning	Type	Length
SG28	LIN-PIA-IMD-MEA-QTY-FTX-SG32-SG33-SG34-SG37-SG38				200000					
SG33	RFF				9999					
61	RFF			Reference	1	C				
	RFF	<b>C506</b>		<b>Reference</b>		R				
	RFF	C506	1153	Reference code qualifier		D	<b>ACE</b> = Related document number		AN	1>3
						D	<b>VN</b> = Order number (supplier)			
	RFF	C506	1154	Reference identifier		R	<.,>		AN	1>70
	RFF	C506	1156	Document line identifier		N			AN	1>6
	RFF	C506	4000	Reference version identifier		N			AN	1>35
	RFF	C506	1060	Revision identifier		N			AN	1>6

*This segment is used to identify references associated with the line item.*

Segment notes:

The use of this segment is **optional**.

Dependency notes:

- Code value ACE can **optionally** be used in case the sender of the order wants to refer to a document number on line level.

Do note however that it's not the intention to take over this number in the DESADV or the INVOIC.

- Code value VN can be used for VMI purposes. Do note however that GS1 Belgium & Luxembourg has no specific recommendations in regards to VMI (yet).

When used, this information overrides what is specified in the heading section (#7) when the same qualifier is used.

Segm.#	Segm.	Composite DE	DE	DE Name	MaxUse	BelgiLux	Value	Meaning	Type	Length
SG28	LIN-PIA-IMD-MEA-QTY-FTX-SG32-SG33-SG34-SG37-SG38				200000					
SG34	PAC				99					
63	PAC			Package	1	C				
	PAC		7224	Package quantity		R	<..>		N	1>8
	PAC	C531		Package type identification		N				
	PAC	C531	7075	Packaging level code		N			AN	1>3
	PAC	C531	7233	Packaging related description code		N			AN	1>3
	PAC	C531	7073	Packaging terms and conditions code		N			AN	1>3
	PAC	C202		Package type		R				
	PAC	C202	7065	Package type description code		R	<RTI list>	Select the corresponding package type description code from the RTI list	AN	1>17
	PAC	C202	1131	Code list identification code		N			AN	1>17
	PAC	C202	3055	Code list responsible agency code		N			AN	1>3
	PAC	C202	7064	Type of packages		R	<GTIN>		AN	1>35
	PAC	C402		Package type identification		N				
	PAC	C402	7077	Description format code		N			AN	1>3
	PAC	C402	7064	Type of packages		N			AN	1>35
	PAC	C402	7143	Item type identification code		N			AN	1>3
	PAC	C402	7064	Type of packages		N			AN	1>35
	PAC	C402	7143	Item type identification code		N			AN	1>3
	PAC	C532		Returnable package details		N				
	PAC	C532	8395	Returnable package freight payment responsibility code		N			AN	1>3
	PAC	C532	8393	Returnable package load contents code		N			AN	1>3

Segm.#	Segm.	Composite DE	DE	DE Name	MaxUse	BelgiLux	Value	Meaning	Type	Length
<p><i>This segment is used in those cases where despatch unit coding has not yet been implemented, yet requirements exist to define the despatch unit to be delivered.</i></p> <p><u>Segment notes:</u></p> <ul style="list-style-type: none"> <li>- The use of this segment is <b>optional</b>. Although redundant when proper data synchronisation is in place, it may be useful to specify <b>how many packages</b> are expected when ordering is done in consumer units (instead of trade units) but should only be used in that case. Do note however that the supplier is not necessarily restricted to use the specified packaging type. Example: PAC+4++BX:::&lt;GTIN trade unit&gt;' implies that 'the 48 units expressed in #51 QTY' are to be packed in 4 boxes.</li> <li>-The RTI list can be downloaded over here: <a href="https://www.gs1.nl/sites/default/files/so_emballagecodes_gs1beneluxrtiist.xlsx">https://www.gs1.nl/sites/default/files/so_emballagecodes_gs1beneluxrtiist.xlsx</a></li> </ul>										



Segm.#	Segm.	Composite DE	DE	DE Name	MaxUse	BelgiLux	Value	Meaning	Type	Length
<b>SG28 LIN-PIA-IMD-MEA-QTY-FTX-SG32-SG33-SG34-SG37-SG38</b>					200000					
<b>SG37 LOC</b>					9999					
<b>69 LOC</b>										
<b>Place/location identification</b>					1	C				
	LOC		3227	Location function code qualifier		R	7 = Place of delivery		AN	1>3
	LOC	<b>C517</b>		<b>Location identification</b>		R				
	LOC	C517	3225	Location name code		R	<GLN>		AN	1>25
	LOC	C517	1131	Code list identification code		N			AN	1>17
	LOC	C517	3055	Code list responsible agency code		R	9 = GS1		AN	1>3
	LOC	C517	3224	Location name		N			AN	1>256
	LOC	<b>C519</b>		<b>Related location one identification</b>		N				
	LOC	C519	3223	First related location name code		N			AN	1>25
	LOC	C519	1131	Code list identification code		N			AN	1>17
	LOC	C519	3055	Code list responsible agency code		N			AN	1>3
	LOC	C519	3222	First related location name		N			AN	1>70
	LOC	<b>C553</b>		<b>Related location two identification</b>		N				
	LOC	C553	3233	Second related location name code		N			AN	1>25
	LOC	C553	1131	Code list identification code		N			AN	1>17
	LOC	C553	3055	Code list responsible agency code		N			AN	1>3
	LOC	C553	3232	Second related location name		N			AN	1>70
	LOC		5479	Relation code		N			AN	1>3

This segment is used to identify the location of delivery for a split delivery order.

**Segment notes:**

To be used in case of a **transshipment** order (BGM+401) to express the GLN (Global location number) of each ultimate destination.

For more information, see 'ORDERS examples'.

Note: Not all companies can easily manage in their ERP an order detailing *multiple* ultimate destinations.

Therefore this practice can only take place if **bilaterally agreed** beforehand.

Segm.#	Segm.	Composite DE	DE	DE Name	MaxUse	BelgiLux	Value	Meaning	Type	Length
<b>SG28 LIN-PIA-IMD-MEA-QTY-FTX-SG32-SG33-SG34-SG37-SG38</b>					200000					
<b>SG38 TAX</b>					10					
<b>72 TAX</b>					1	C				
				<b>Duty/tax/fee details</b>						
	TAX		5283	Duty or tax or fee function code qualifier	R		7 = Tax		AN	1>3
	TAX	<b>C241</b>		<b>Duty/tax/fee type</b>	R					
	TAX	C241	5153	Duty or tax or fee type name code	R		VAT = Value added tax		AN	1>3
	TAX	C241	1131	Code list identification code	N				AN	1>17
	TAX	C241	3055	Code list responsible agency code	N				AN	1>3
	TAX	C241	5152	Duty or tax or fee type name	N				AN	1>35
	TAX	<b>C533</b>		<b>Duty/tax/fee account detail</b>	N					
	TAX	C533	5289	Duty or tax or fee account code	N				AN	1>6
	TAX	C533	1131	Code list identification code	N				AN	1>17
	TAX	C533	3055	Code list responsible agency code	N				AN	1>3
	TAX		5286	Duty or tax or fee assessment basis value	N				AN	1>15
	TAX	<b>C243</b>		<b>Duty/tax/fee detail</b>	R					
	TAX	C243	5279	Duty or tax or fee rate code	N				AN	1>7
	TAX	C243	1131	Code list identification code	N				AN	1>17
	TAX	C243	3055	Code list responsible agency code	N				AN	1>3
	TAX	C243	5278	Duty or tax or fee rate	R		<.> Indicate 2 decimals (e.g. "6.00")		AN	1>17
	TAX	C243	5273	Duty or tax or fee rate basis code	N				AN	1>12
	TAX	C243	1131	Code list identification code	N				AN	1>17
	TAX	C243	3055	Code list responsible agency code	N				AN	1>3
	TAX		5305	Duty or tax or fee category code	N				AN	1>3
	TAX		3446	Party tax identifier	N				AN	1>20
	TAX		1227	Calculation sequence code	N				AN	1>3

*This segment is used to identify the type and rate of tax that is applicable for the current line item.*

**Segment notes:**

Whenever possible this segment should be avoided. Therefore only use this if really necessary e.g. for certain **webEDI** to take over in the invoice.

Segm.#	Segm.	Composite DE	DE	DE Name	MaxUse	BelgiLux	Value	Meaning	Type	Length
<b>91 UNS Section control 1 M</b>										
	UNS		0081	Section identification		R		S = Detail/summary section separation	A	1>1
<i>This segment is a <u>mandatory</u> UN/EDIFACT segment used to separate the detail and summary sections of the message.</i>										
<b>94 UNT Message trailer 1 M</b>										
	UNT		0074	Number of segments in the message		R	<..>		N	1>6
	UNT		0062	Message reference number		R	<..>		AN	1>14
<i>This segment is a <u>mandatory</u> UN/EDIFACT segment. It must always be the last segment in the message before the interchange trailer segment UNZ.</i>										
<b>UNZ Interchange trailer 1 M</b>										
	UNZ		0036	Interchange control count		R	<..>	Number of messages within the interchange	N	1>6
	UNZ		0020	Interchange control reference		R	<..>	Identical to DE 0020 in UNB segment	AN	1>14
<i>This segment is to provide the trailer of an interchange (serves as envelope).</i>										



**Harmonized Order to Cash (HO2C) V3  
ORDERS examples**

**Content**

<b>1. Simple order</b> (for DC delivery)	4
<b>2. Order type</b>	5
Direct delivery	
Cross dock order (only 1 ultimate destination)	
Transshipment order ('n' ultimate destinations, cf. alloti)	
Transshipment order containing free goods and variable weight goods.	
Backhauling order	
Platform order (cf. C3C)	
(Season) reservation order	
Actual order referring to the season reservation order	
WebEDI order (requiring price and VAT rate)	
Goods in consignment	
Home delivery	
<b>3. Type of goods</b>	16
Promotional articles	
Displays	
Free goods	
Only free goods ordered	
Variable weight products	
Variable weight including free goods	
Empty RTI	
Priority goods	
Consumer units	
<b>4. What-ifs</b>	20

**Log of changes:**

<b>Version</b>	<b>Date</b>	<b>Change</b>
<b>3.0</b>	1.06.2019	- Changed url RTI-list from <a href="https://www.gs1.nl/sites/default/files/so_emballagecodes_gs1beneluxrtiist.pdf">https://www.gs1.nl/sites/default/files/so_emballagecodes_gs1beneluxrtiist.pdf</a> into <a href="https://www.gs1.nl/sites/default/files/so_emballagecodes_gs1beneluxrtiist.xlsx">https://www.gs1.nl/sites/default/files/so_emballagecodes_gs1beneluxrtiist.xlsx</a>
<b>2.0</b>	1 04 2017	- Added scenarios home delivery - Changed code for promotional deals from PD to ACE
<b>1.0</b>	July 2014	- Making document available

**Contact:**[fmcg-foodservice@gs1belu.org](mailto:fmcg-foodservice@gs1belu.org)

+32 (0) 2 229 18 88

**1. Simple ORDERS** (for DC delivery)

**Example:** Customer orders 40 units of GTIN1 and 10 units of GTIN2 to be delivered to the distribution center (identified by GLN 5411111000554).

#		
1	<b>UNH</b> +4103+ <b>ORDERS</b> :D:01B:UN:EAN010'	Message header
2	<b>BGM</b> +220+1202+9'	The order number is 1202
3	<b>DTM</b> +137:20140420:102'	Message date 20th of April 2014
3	<b>DTM</b> +2:20140530:102'	Requested delivery date 30th of May 2014
9	<b>NAD</b> +BY+5411111000004::9'	Buyer identified by GLN 5411111000004
9	<b>NAD</b> +SU+5422222000005::9'	Supplier identified by GLN 5422222000005
9	<b>NAD</b> +DP+5411111000554::9'	The goods are to be delivered to GLN 5411111000554
47	<b>LIN</b> +1++5422222001001:SRV'	Ordered article has GTIN 5422222001001
51	<b>QTY</b> +21:40'	Ordered quantity 40
47	<b>LIN</b> +2++5422222002003:SRV'	Ordered article has GTIN 5422222002003
51	<b>QTY</b> +21:10'	Ordered quantity 10
91	<b>UNS</b> +S'	
94	<b>UNT</b> +13+4103'	In total, there are 13 segment lines



**2. Order type**

**Example 1: Direct delivery.** *The customer orders goods to be delivered directly to the store.*

#		
1	UNH+4103+ORDERS:D:01B:UN:EAN010'	
2	BGM+220+1202+9'	
3	DTM+137:20140420:102'	
3	DTM+2:20140530:102'	Requested delivery date 30th of May 2014
9	NAD+BY+5411111000002::9'	Buyer identified by GLN 5411111000002
9	NAD+SU+5422222000005::9'	Supplier identified by GLN 5422222000005
9	NAD+DP+5411111001827::9'	The goods are to be delivered to the store (identified by GLN 5411111001827).
47	LIN+1++5422222001001:SRV'	Ordered article has GTIN 5422222001001
51	QTY+21:40'	Ordered quantity 40
47	LIN+2++5422222002003:SRV'	Ordered article has GTIN 5422222002003
51	QTY+21:10'	Ordered quantity 10
91	UNS+S'	
94	UNT+13+4103'	

**Note:** It's recommended to order in 'trade units' (rather than in consumer units).

**Note 2:** An order can have only 1 delivery address.

**Example 2: Cross dock order.** The customer orders goods to be delivered to the distribution center, but informs the supplier about the (1) final destination for which the goods are ultimately intended.

#		
1	<b>UNH</b> +4103+ORDERS:D:01B:UN:EAN010'	
2	<b>BGM</b> +237+1202+9'	Cross docking services order
3	<b>DTM</b> +137:20140420:102'	Message date 20th of April 2014
3	<b>DTM</b> +2:20140530:102'	Requested delivery date 30th of May 2014
9	<b>NAD</b> +BY+5411111000002::9'	Buyer identified by GLN 5411111000002
9	<b>NAD</b> +SU+5422222000005::9'	Supplier identified by GLN 5422222000005
9	<b>NAD</b> +DP+5411111000559::9'	The goods are to be delivered to GLN 5411111000559
9	<b>NAD</b> +UC+5411111001827::9'	The final destination for the goods is the store (identified by GLN 5411111001827).
47	<b>LIN</b> +1++5422222001001:SRV'	Ordered article has GTIN 5422222001001
51	<b>QTY</b> +21:40'	Ordered quantity 40
47	<b>LIN</b> +2++5422222002003:SRV'	Ordered article has GTIN 5422222002003
51	<b>QTY</b> +21:10'	Ordered quantity 10
91	<b>UNS</b> +S'	
94	<b>UNT</b> +14+4103'	

**Example 3: Transshipment order.** The customer orders goods for **multiple** ultimate destinations. The goods are to be delivered to the distribution center but need to be packed according to the final delivery point.

Note that this method of ordering is only done provided it's **bilaterally agreed beforehand** between the sender and the receiver. This is because not every company's ERP system allows to manage *multiple* ultimate destinations in one order.

#		
1	UNH+4103+ORDERS:D:01B:UN:EAN010'	Transshipment order Message date 20th of April 2014 Requested delivery date 30th of May 2014
2	BGM+401+1202+9'	
3	DTM+137:20140420:102'	
3	DTM+2:20140530:102'	
9	NAD+BY+5411111000002::9'	Buyer identified by GLN 5411111000002
9	NAD+SU+5422222000005::9'	Supplier identified by GLN 5422222000005
9	NAD+DP+5411111000559::9'	The goods are to be delivered to GLN 5411111000559
47	LIN+1++5422222001001:SRV'	Ordered article has GTIN 5422222001001
51	QTY+21:20'	Ordered quantity 20
69	LOC+7+5411111001827::9'	20 units GTIN1 are to be packed for store <b>1</b>
47	LIN+2++5422222002003:SRV'	Ordered article has GTIN 5422222002003
51	QTY+21:10'	Ordered quantity 10
69	LOC+7+5411111001827::9'	10 units GTIN2 are also to be packed for store <b>1</b>
47	LIN+3++5422222001001:SRV'	
51	QTY+21:18'	18 units GTIN1 are intended for store <b>2</b> .
69	LOC+7+5411111004555::9'	
	...	
91	UNS+S'	
94	UNT+24+4103'	

**Example 4: Transshipment order containing free goods and variable weight goods.**

47	...	}	20 payable units and 2 free units on top, for store 1
51	LIN+1++5422222002003:SRV'		
69	QTY+21:20'		
47	LOC+7+5411111001827::9'	}	115 kg variable weight goods for store 1
51	LIN+2++5422222002003:SRV'		
69	QTY+192:2'		
47	LOC+7+5411111001827::9'	}	115 kg payable + 12 kg free on top, for store 2
51	LIN+3++95422222001001:SRV'		
69	MEA+PD+AAC+KGM:115'		
47	QTY+21:1'	}	
51	LOC+7+5411111001827::9'		
69	LIN+4++95422222001001:SRV'		
47	MEA+PD+AAC+KGM:115'	}	
51	QTY+21:1'		
69	LOC+7+5411111004555::9'		
47	LIN+5++95422222001001:SRV'	}	
51	MEA+PD+AAC+KGM:12'		
69	QTY+192:1'		
...	LOC+7+5411111004555::9'	}	
...	...		
...	...		

**Example 5: Backhauling order.** This case assumes that the customer arranges transport/picks up the goods. The customer sends an order and explicitly specifies this by using TOD+4 and NAD+SF (= Ship from).

#		
1	UNH+4103+ORDERS:D:01B:UN:EAN010'	
2	BGM+220+1202+9'	
3	DTM+137:20140420:102'	
3	DTM+2:20140530:102'	Due to the presence of TOD+4 and NAD+SF, DTM+2 is to be interpreted as 'requested pick up date' (instead of requested delivery date).
9	NAD+BY+5411111000002::9'	
9	NAD+SU+5422222000005::9'	
9	NAD+SF+5422222000005::9'	NAD+SF is to be interpreted as the 'pick up address'.
9	NAD+DP+5411111001827::9'	
26	TOD+4++EXW'	TOD+4 is minimally required. The code value 'EXW' however is optional.
47	LIN+1++5422222001001:SRV'	Ordered article has GTIN 5422222001001
51	QTY+21:40'	Ordered quantity 40
47	LIN+2++5422222002003:SRV'	Ordered article has GTIN 5422222002003
51	QTY+21:10'	Ordered quantity 10
91	UNS+S'	
94	UNT+15+4103'	

Note that NAD+DP (= delivery address) is mentioned in the order as well; this allows the supplier to take over this information in the DESADV.

**Example 6: Platform order** (also referred to as 'C3C'). This case assumes that the supplier keeps its stock on the customer's platform. The customer orders goods to be delivered from the platform. Generally the customer sends the order to both the supplier and the platform. (Optionally, the supplier sends an instruction to its logistics service provider via HANMOV.) The platform does the picking and creates the DESADV. Afterwards, ideally, the supplier creates the INVOIC based on the DESADV.

#		
1	UNH+4103+ORDERS:D:01B:UN:EAN010'	
2	BGM+220+1202+9'	
3	DTM+137:20140420:102'	
3	DTM+2:20140530:102'	
9	NAD+BY+5411111000002::9'	
9	NAD+SU+5422222000005::9'	
9	NAD+SF+5422222000005::9'	NAD+SF contains the GLN of the platform where the goods are stored.
9	NAD+DP+5411111001827::9'	
47	LIN+1++5422222001001:SRV'	Ordered article has GTIN 5422222001001
51	QTY+21:40'	Ordered quantity 40
47	LIN+2++5422222002003:SRV'	Ordered article has GTIN 5422222002003
51	QTY+21:10'	Ordered quantity 10
91	UNS+S'	
94	UNT+14+4103'	

**Example 7: (Season) reservation order.** The purpose of the order is to reserve the total quantity in advance, but the actual order is to follow.

#		
1	UNH+4103+ORDERS:D:01B:UN:EAN010'	
2	BGM+221+1202+9'	It concerns a blanket order. Earliest delivery date. Latest delivery date. (optional)
3	DTM+137:20140420:102'	
3	DTM+64:20140530:102'	
3	DTM+63:20140820:102' (optional)	
7	RFF+ACE:12345'	Provided an agreement was made beforehand, then its document number is specified via RFF+ACE.
9	NAD+BY+5411111000002::9'	
9	NAD+SU+5422222000005::9'	
9	NAD+DP+5411111001827::9' (optional)	
47	LIN+1++5422222001001:SRV'	Ordered article has GTIN 5422222001001
51	QTY+21:300'	Ordered quantity 300
47	LIN+2++5422222002003:SRV'	Ordered article has GTIN 5422222002003
51	QTY+21:60'	Ordered quantity 60
91	UNS+S'	
94	UNT+15+4103'	

**Example 8: Actual order referring to the (season) reservation order.**

#		
1	UNH+4103+ORDERS:D:01B:UN:EAN010'	
2	BGM+220+1407+9'	This document number (same as in the initial reservation order) is to be taken over in the invoice.
3	DTM+137:20140420:102'	
3	DTM+2:20140530:102'	
7	RFF+ACE:12345'	
9	NAD+BY+5411111000002::9'	
9	NAD+SU+5422222000005::9'	
9	NAD+DP+5411111001827::9'	
47	LIN+1++5422222001001:SRV'	Ordered article has GTIN 5422222001001
51	QTY+21:40'	Ordered quantity 40
47	LIN+2++5422222002003:SRV'	Ordered article has GTIN 5422222002003
51	QTY+21:10'	Ordered quantity 10
91	UNS+S'	
94	UNT+14+4103'	

**Example 9: WebEDI order.** This case assumes that the supplier (= receiver of the order) uses a 'webEDI solution'. Some webEDI solutions require additional information in the order (such as the article price, VAT rate, ...) to easily create the despatch advice and the invoice. Nevertheless, ideally the EDI solution provider should foresee an article database (to avoid sending this additional information via the order).

#		
1	UNH+4103+ORDERS:D:01B:UN:EAN010'	
2	BGM+220+1202+9'	
3	DTM+137:20140420:102'	
3	DTM+2:20140530:102'	
9	NAD+BY+5411111000002::9++BUYER NAME+STREET AND NR+CITY++POSTAL CODE+BE'	Buyer identified by GLN 5411111000002 and full written name & address
9	NAD+SU+5422222000005::9++SUPPLIER NAME+STREET AND NR+CITY++POSTAL CODE+BE'	Supplier identified by GLN 5422222000005 and full written name & address
9	NAD+DP+5411111000559::9++DC NAME+STREET AND NR+CITY++POSTAL CODE+BE'	Delivery party identified by GLN and full written name & address
17	CUX+2:EUR:9'	Currency
47	LIN+1++5422222001001:SRV'	Ordered article has GTIN 5422222001001
49	IMD+F+:::<article description>'	Article description
51	QTY+21:40'	Ordered quantity 40
58	PRI+AAA:<price amount>:CT:CP:1:PCE'	Article price
72	TAX+7+VAT+:::6.00'	VAT rate
91	UNS+S'	
94	UNT+15+4103'	

**Note:** Under no circumstances is the order to generate an action from the supplier in case the (optionally mentioned) article price is different from what was commercially agreed. In spite of that the supplier may of course contact the customer but he/she's not expected to do so.



**Example 10: Goods in consignment.** Order to deliver goods into stock with agreement on payment when goods are sold out of this stock.

#		
1	UNH+4103+ORDERS:D:01B:UN:EAN010'	It concerns a consignment order.
2	BGM+227+1202+9'	
3	DTM+137:20140420:102'	Requested delivery date
3	DTM+2:20140530:102'	
7	REF+ACE:12345' (optional)	Optionally refer to an agreement.
9	NAD+BY+5411111000002::9'	
9	NAD+SU+5422222000005::9'	
9	NAD+DP+5411111001827::9'	
47	LIN+1++5422222001001:SRV'	Ordered article has GTIN 5422222001001
51	QTY+21:40'	Ordered quantity 40
47	LIN+2++5422222002003:SRV'	Ordered article has GTIN 5422222002003
51	QTY+21:10'	Ordered quantity 10
91	UNS+S'	
94	UNT+14+4103'	

**Note:** When to invoice goods, is to be bilaterally agreed beforehand.

**Example 11: home delivery**

In case of home delivery an end consumer orders goods on the website of the retailer and indicates that the goods:

- have to be delivered at home (delivery address = invoice address)
- have to be delivered at an alternative address like the house of a relative or at work (delivery address ≠ invoice address)
- will be picked up in one of the stores of the retailer

The retailer sends the order to the supplier who needs to deliver the goods on the indicated location.

**Example 11a: delivery at home**

<p># ...                  1 UNH+4103+ORDERS:D:01B:UN:EAN010 '                  2 BGM+220+1202+9 '                  3 DTM+137:20140420:102 '                  3 DTM+2:20140530:102 ' OR OPTIONAL                  DTM+2:201405301200201405301800:719 '                    9 NAD+BY+5411111000004::9 '                  9 NAD+SU+5422222000005::9 '                  9 NAD+DP+0000000000000::9 '                    9 NAD+UC+0000000000000::9++                  NAME END CONSUMER+                  STREET AND NR+CITY++POSTAL                  CODE+COUNTRY CODE '                  13 CTA+PD '                  14 COM+PHONE NUMBER:TE '                  14 COM+E-MAIL ADDRESS:EM '</p>	<p>Requested delivery date OR                  Requested delivery date and part of the day                  (morning or afternoon / blocks of 4 hours)</p> <p>(2) DP: Dummy GLN with no extra attributes                  =&gt; delivery address end consumer = invoice                  address end consumer                  (1) UC: Dummy GLN =&gt; home delivery order.                  Name and address of the end consumer.</p> <p>Contact details of the end consumer                  Phone number of the end consumer                  E-mail address of the end consumer</p>
<p>47 LIN+1++5422222001002:SRV '                  51 QTY+21:40 '                  47 LIN+2++5422222002009:SRV '                  51 QTY+21:10 '                  ...</p>	

**Example 11b: delivery at an alternative address**

#	...		
1	UNH+4103+ORDERS:D:01B:UN:EAN010'		
2	BGM+220+1202+9'		
3	DTM+137:20140420:102'	Requested delivery date OR Requested delivery date and part of the day (morning or afternoon / blocks of 4 hours)	
3	DTM+2:20140530:102' OR OPTIONAL		
	DTM+2:201405301200201405301800:719'		
9	NAD+BY+5411111000004::9'	(2) DP: Dummy GLN with extra attributes => delivery address end consumer ≠ invoice address end consumer This is the address of a relative or the address of the company the end consumer works. Name employee (delivery at work) (1) UC: Dummy GLN => home delivery order. Name and address of the end consumer Name and address end consumer Contact details of the end consumer Phone number of the end consumer E-mail address of the end consumer	
9	NAD+SU+5422222000005::9'		
9	NAD+DP+0000000000000::9++ NAME RELATIVE OR COMPANY EMPLOYER END CONSUMER+ STREET AND NR+CITY++POSTAL CODE+COUNTRY CODE'		
13	CTA+GR+:NAME EMPLOYEE'		
9	NAD+UC+0000000000000::9++NAME END CONSUMER+STREET AND NR+CITY++POSTAL CODE+COUNTRY CODE'		
13	CTA+PD'		
14	COM+PHONE NUMBER:TE'		
14	COM+E-MAIL ADDRESS:EM'		
47	LIN+1++5422222001002:SRV'		
51	QTY+21:40'		
47	LIN+2++5422222002009:SRV'		
51	QTY+21:10'		
	...		

**Example 11c: pick up in the shop**

#	...	
1	UNH+4103+ORDERS:D:01B:UN:EAN010'	
2	BGM+220+1202+9'	
3	DTM+137:20140420:102'	Requested delivery date (in this case there is no need for a range)
3	DTM+2:20140530:102'	
9	NAD+BY+5411111000004::9'	(2) DP: Real GLN => delivery address end consumer ≠ invoice address end consumer The alternative delivery address is a shop. (1) UC: Dummy GLN => home delivery order.
9	NAD+SU+5422222000005::9'	
9	NAD+DP+5411111000559::9'	
9	NAD+UC+0000000000000::9'	
9	NAD+UC+0000000000000::9'	
47	LIN+1++5422222001002:SRV'	
51	QTY+21:40'	
47	LIN+2++5422222002009:SRV'	
51	QTY+21:10'	
	..	

## Type of goods

### **Example 1: Promotional articles**

**Note:** Ideally each promotional article should have its own unique GTIN. Only if this is not the case, specify (#57) **FTX+PUR+++<free text>**' and **optionally** mention (#61) **RFF+ACE:<promotion deal n°>**.

Furthermore the best practice points out that preferably a **separate** order is created for promotional articles.

### **Example 2: Displays**

Nothing out of the ordinary to mention. Ideally, the display (containing the component articles) is ordered by one GTIN.

**Example 3: Free goods:** Order detailing 20 payable units and 2 free units on top.

<pre> 47 ... 51 LIN+1++5422222002003:SRV' QTY+21:20' 47 LIN+2++5422222002003:SRV' 51 QTY+192:2' 47 LIN+3++5422222001001:SRV' 51 QTY+21:60' ...                 </pre>	<p>Note that if both a regular (payable) and a free (non-payable) quantity are mentioned in the same orders message, then the LIN segment is to be repeated to specify these 2 quantities separately from one another.</p> <p>20 payable units and 2 free (non-payable) units on top</p>
---	--

How to recognize/**match** free goods throughout the ORDERS, DESADV & INVOIC?

ORDERS	DESADV	INVOIC
<pre> LIN+1++&lt;GTIN1&gt;:SRV' QTY+21:10' (payable) LIN+2++&lt;GTIN1&gt;:SRV' QTY+192:2' (non-payable)                 </pre>	<pre> LIN+1++&lt;GTIN1&gt;:SRV' QTY+12:12' (despatched)                 </pre>	<pre> LIN+1++&lt;GTIN1&gt;:SRV' IMD+F++IN::9:Towel' QTY+46:12' (delivered) QTY+192:2' (non-payable) QTY+47:10' (invoiced) MOA+203:800' PRI+AAA:80' PRI+AAB:80' TAX+7+VAT+++:::21' MOA+125:800'                 </pre>

**Example 3': Only free goods ordered:** The best practice points out that it works easier to order free (non-payable) goods separately from the regular goods; meaning **sending an order containing only the 'free non-payable' quantity**, and another order detailing the payable quantity. This separation appears to simplify certain validation checks or procedures.

How to cover the ORDERS, DESADV & INVOIC in case only free quantity is ordered?

ORDERS	DESADV	INVOIC
<pre> LIN+1++&lt;GTIN1&gt;:SRV' QTY+192:2' (non-payable)                 </pre>	<pre> LIN+1++&lt;GTIN1&gt;:SRV' QTY+12:2' (despatched)                 </pre>	<pre> LIN+1++&lt;GTIN1&gt;:SRV' IMD+F++IN::9:Towel' QTY+46:2' (delivered) QTY+192:2' (non-payable) QTY+47:0' (invoiced) MOA+203:0' PRI+AAA:80' PRI+AAB:80' TAX+7+VAT+++:::21' MOA+125:0'                 </pre>

**Example 4: Variable weight products:** *The customer orders 115 kg bulk goods.*

47 ... 50 <b>LIN</b> +3++95422222001001:SRV' 51 <b>MEA</b> +PD+AAC+KGM:115' <b>QTY</b> +21:1' ...	Note that the MEA segment expresses the ordered quantity in kg, l or m. The QTY segment however expresses 'ordered quantity' = 1.
---	---

**Example 5: Variable weight including free goods:** *The customer orders 115 kg bulk goods and 12 kg non-payable on top.*

47 ... 50 <b>LIN</b> +4++95422222001001:SRV' 51 <b>MEA</b> +PD+AAC+KGM:115' <b>QTY</b> +21:1`  47 <b>LIN</b> +5++95422222001001:SRV' 50 <b>MEA</b> +PD+AAC+KGM:12` 51 <b>QTY</b> +192:1' ...	Note that an order containing both regular (payable) and free (non-payable) goods, has a repeating LIN segment specifying the payable quantity in one LIN segment group, and the non-payable quantity in the other LIN segment group.
--	---

**Example 6: Empty RTI:** The customer orders 48 RTI's of type nGRAI1 and 20 RTI's of type nGRAI2.

47	...	Asset type is identified by nGRAI1
47	<b>LIN+1</b> '	
48	<b>PIA</b> +5+nGRAI-1:SUE '	
51	<b>QTY</b> +21:48 `	
47	<b>LIN</b> +2 '	
48	<b>PIA</b> +5+nGRAI-2:SUE '	
51	<b>QTY</b> +21:20 '	
	...	

The nGRAI can be found on GS1 BeNeLux RTI list:

[https://www.gs1.nl/sites/default/files/so\\_emballagecodes\\_gs1beneluxrtiist.xlsx](https://www.gs1.nl/sites/default/files/so_emballagecodes_gs1beneluxrtiist.xlsx)

**Example 7: Priority goods:** If bilaterally agreed beforehand, the customer can indicate for one (or several) GTIN(s) that this(/these) definitely have to be delivered, by using (#57) FTX+PUR+++<Purchasing information "PRIOR">.

**Example 8: Consumer units:** Although it's recommended to order in trade units, for a few specific business cases (e.g. for French suppliers) the customer can order in consumer units, and *optionally* add some details for information purposes.

47	...	The ordered GTIN is a consumer unit (instead of a trade unit). 480 consumer units are ordered. The customer expects 12 consumer units per trade unit. The 480 ordered consumer units are expected to be packed in 40 boxes.
47	<b>LIN</b> +1++5422222002301:SRV'	
48	<b>IMD</b> +C++CU'	
51	<b>QTY</b> +21:480'	
51	<b>QTY</b> +59:12'	
63	<b>PAC</b> +40++BX:::5422222002301'	
	...	

**Note:** Even if ordering is done in consumer units (instead of the recommended trade units), take over the **same GTIN** in the despatch advice and invoice to ensure the matching of goods (= Order to Cash principle).

#### 4. What-ifs...

##### **What if the supplier does not recognize the article code in the order?**

The supplier is to **contact** the customer to decide which action to take.

Even if the system at supplier's side '**automatically**' rejects certain article codes, the supplier should contact the customer to agree how to proceed (instead of replacing it by another article, or deliver no article at all).

Furthermore, assuming that the supplier and the customer agree to deliver another article, then the best practice is to change the initial order **internally** at customer's side (rather than using a Purchase Order Change Request/ORDCHG) or to simply send a new order.

##### **What if the supplier has to take into account different packing requirements per ultimate customer?**

Ideally each article that needs to be distinguishable from another should have its **own GTIN** (rather than making the distinction via an optional segment line such as #48 PIA+1+<buyer's item number>:IN').

##### **What if the supplier does not have sufficient quantity to deliver?**

The EDI Committee decided to **not** foresee a recommendation for this case.

##### **What if a back order is used?**

The EDI Committee decided to **not** foresee a recommendation for this case.

##### **What if the supplier identifies his trade unit by the 'GTIN-13 of his consumer unit' preceded by '0'?**

The supplier is to allocate a **new** GTIN to his trade unit. Either a 'GTIN-14 with leading n° 1-9' or another GTIN-13.

##### **What if '1 and the same article' is identified by**

- **GTIN1 in case it concerns 'units'**
- **and GTIN2 in case it concerns 'kg'?**

In that case it's recommended to use the **same GTIN** for the article in kg and in units but to specify both measurement units in the invoice. (For more information, see INVOIC examples).

##### **How to order non-branded articles (e.g. non-branded fruit/vegetables)?**

In case there are multiple suppliers (e.g. for Jonagold apples), the best practice is to order the **supplier's GTIN**. If it concerns a private label, order by retailer's GTIN.



**What if the customer or the supplier wants to correct/cancel the initial order?**

Contact the business partner (by mail/phone) and decide how to proceed (E.g. cancel the order and place a new one).

Reasons why not to cover this via EDI (*BGM DE 1225=5, replace*) :

- A 'correction via EDI' is not necessarily more efficient (E.g. What if supplier already prepared the order and can't change it anymore).
- Would require (possibly) complex technical configurations.
- Not all web solutions would be able to treat this correctly.

